

NUTRITION GUIDE

for B.C. Sheep Producers

B.D. (Steve) Mason, Ph.D., P.A.S.

Livestock Nutritionist

Basil Bactawar, MSc., P.Ag.

Livestock Scientist and Nutritionist



**BRITISH
COLUMBIA**

Ministry of Agriculture,
Fisheries and Food

Canadian Cataloguing in Publication Data

Mason, Brian D. (Steve), 1945-
Nutrition guide for B.C. sheep producers

Revision of: Ministry of Agriculture and Lands, 1985, 2004 and 2010.
Includes index.
ISBN 0-7726-2199-3

1. Sheep – British Columbia – Feeding and feeds.
2. Lambs – British Columbia – Feeding and feeds.
 - I. British Columbia. Ministry of Agriculture and Lands. Title. II.

SF376.M37 1994

636.3'085

C94-960257-4

This Publication was produced by:

**British Columbia Ministry of Agriculture and Lands
808 Douglas Street
Victoria, B.C.
V8W 2Z7
(604) 387-3498**

**Reprinted
2010**

Acknowledgements

The authors wish to acknowledge those who reviewed the first draft of this Guide. In particular, many constructive suggestions were received from Dr. Malcolm Tait, Don Scheer, John Knapp, Al McNeil, Arvo Koppel, Carl Rose and Kent Gwilliam. Ms. Kay McCarthy patiently typed and edited the manuscript, our first major effort using the

Wang word processor. J.A. Pelter supported, goaded and provided much of the inspiration required to bring the idea to fruition. We would also like to thank Sarah Pearce for helping in the typing of the updated version in 2004 and Connie Duivenvoorden for typing the version in 2010.

Figure Credits

Figure B3 and B4

Dr. J. W. Costerton
Department of Biology
University of Calgary

Figure B7

Dr. R. M. Tait
Department of Animal Science
University of British Columbia

Figure D2

Charles Finch
Cawston, B.C.

Figure E3

“Sheep Production:
Science into Practice”
Andrew W. Speedy
Longman Group Ltd.

Figures E5, E6 and E9

Canada Plan Service

Figures E10 and E15

Midwest Plan Service

Figure E13

“Grass Farming”
M. McG. Cooper and
D. W. Morris
Farming Press Ltd.

Figure E16

Raising Sheep the Modern Way
Paula Simmons
Garden Way Publishing

Figure E18

Dr. Cliff Hadfield

Table of Contents

Page

INTRODUCTION	1
SECTION A – FEEDS	2
FEED COMPOSITION	2
The Growth of Forages	2
Carbohydrates.....	2
Fats and Oils.....	2
Lignin	2
Proteins.....	2
Minerals	3
Vitamins	3
FEED ANALYSIS	3
Dry Matter	3
Fibre.....	4
Total Digestible Nutrients	4
Protein	4
Minerals	5
Silage pH	6
Bushel Weight	6
NEAR INFRARED REFLECTANCE (NIR) SPECTROSCOPY	6
FACTORS AFFECTING FEED QUALITY.....	7
SECTION B -- THE DIGESTION OF FEED	8
MONOGASTRIC DIGESTION.....	8
THE SHEEP'S DIGESTIVE SYSTEM	9
Development of the Ruminant Stomach	10
The Esophageal Groove	11
Effect of Feeding Management.....	11
CARBOHYDRATE DIGESTION	12
Monogastric Carbohydrate Digestion.....	12
Ruminant Carbohydrate Digestion.....	12
Volatile Fatty Acids	12
Cellulose Digestion.....	12
Other Carbohydrates.....	13
PROTEIN DIGESTION.....	13
Amino Acids	13
Monogastric Protein Digestion.....	14
Protein Quality.....	14
Ruminant Protein Digestion.....	15
Urea in Sheep Rations	16
Bypass Protein.....	17
Heat Damaged Protein.....	17
SECTION C -- NUTRIENT REQUIREMENTS	18
ESSENTIAL NUTRIENTS	18
Water	18
Energy	19
Effect of Environment on Energy Requirements	20

Effect of Physical Activity on Energy Requirements	21
Energy Sources.....	21
Protein	22
Protein Sources.....	23
Minerals	23
Mineral Sources	24
Vitamins	27
Vitamin Sources.....	29
Balanced Rations.....	29
Priority for Nutrients.....	29
NUTRIENT REQUIREMENTS OF EWES	30
Liveweight and Condition Score Targets	30
Feed Intake	31
Maintenance	31
Flushing	32
Early Pregnancy.....	33
Mid-Pregnancy.....	33
Late Pregnancy.....	34
Lactation	34
Non-Nutritional Factors Affecting Milk Production	35
Milking Sheep.....	35
Separate Feeding of Ewes with Multiple Lambs	36
Special Requirements of Ewe Lambs.....	36
Targets for Ewe Lambs	36
NUTRIENT REQUIRMENTS OF LAMBS	37
How Lambs Grow.....	38
Feed Intake	38
Maintenance and Gain	39
Breed Variation	39
Effect of Sex.....	40
Ratio of Fat to Lean.....	40
Stages of Lamb Growth Pre-Weaning	40
Post Weaning.....	40
Finishing.....	41
Growing Replacement Ewe Lambs	41
NUTIRIENT REQUIRMENTS OF RAMS.....	42
SECTION D – FEED TESTING AND RATION FORMULATION.....	43
FEED SAMPLING	43
Sampling Hay.....	43
Sampling Silage	44
Sampling Grain and Mixed Feeds	44
Interpretation of Analysis Reports.....	44
RATION FORMULATION.....	44
Example 1 – Pearson Square.....	44
Example 2.....	46
Computerized Ration Formulation	47
Ration Recipes.....	47
SECTION E – FEEDING MANAGEMENT	48
CONDITION SCORING EWES	48
The Uses of Condition Scoring.....	49

ALLOCATING FEED RESOURCES.....	49
Feed Wasting.....	50
Ration Changes	51
MINERAL FEEDING.....	51
ADMINISTERING VITAMINS	52
GRAZING MANAGEMENT	53
STARTING NEWBORN LAMBS.....	53
ORPHAN LAMBS.....	54
CREEP FEEDING	54
Design of the Creep Area	55
Lamb Psychology.....	56
Creep Ration.....	56
Expected Results	56
CREEP FEEDING ON PASTURE	57
Forward Creep Grazing.....	57
WEANING	58
When to Wean	58
Weaning in Confinement	59
Weaning on Pasture.....	59
FEEDING WEANED LAMBS.....	59
Cost Efficient Gains.....	59
Feedlot Lambs	60
Feed Intake	60
Processing Forages for Lambs.....	61
Whole Grains in Lamb Rations.....	61
Feeding Behaviour	61
Slotted Floors.....	62
Pasture Lambs.....	62
Annual Pastures.....	63
Shearing Lambs	63
Castrating Ram Lambs.....	63
FEED ADDITIVE AND GROWTH PROMOTERS.....	63
Antibiotics.....	64
Coccidiostats.....	64
MARKET LAMB APPRAISAL	64
APPENDIX I AVERAGE ANALYSES OF B.C. FEEDS	66
APPENDIX II NUTRIENT REQUIREMENT TABLES.....	68
APPENDIX III EXAMPLE RATIONS FOR SHEEP.....	94
INDEX	104

Introduction

The primary goal of any commercial sheep enterprise must be to achieve maximum production at minimum cost. It is the margin between the returns from marketable products and costs of production which determines profitability. Since feed costs usually constitute 60-80% of the total costs of production, it is imperative that feed resources are used to maximize advantage.

The economic realities of sheep production today demand a solid understanding of the principles of nutrition leading to the application of sound and profitable management practices. Knowledge of both the nutrient value of available feeds as well as the nutrient requirements of the livestock is essential in order to profitably allocate feed resources.

This guide attempts to put feeding management practices into the whole context of sheep nutrition. Section A deals with the characteristics of feeds and the criteria used to evaluate their feeding value. Section B is intended to provide a background of basic information on the way in which the sheep utilizes feed. Although some of these ideas may seem academic at first glance, they are intended to provide an understanding of the principles which dictate the success (or failure) of management practice. For example, creep feeding works because early consumption of solid feed promotes rumen development.

The nutrient requirements of sheep are discussed in Section C and tabulated in Appendix II. This information is based on a tremendous volume of ongoing research, recently summarized in the US National Research Council publication, "Nutrient Requirements of Small Ruminants: Sheep, Goats,

Cervids and New World Camelids, Revised Edition, 2006".

Markets, economics and genetics all affect feeding practices. In the past decade, a market for sheep dairy products has been developed. This has led to increased popularity of dairy breeds like the East Friesian which as, in turn, affected feeding practices and nutrient requirements. Likewise, the economics of lamb production demand larger lamb crops with the result that more research has been done on the nutrient requirements of ewes carrying and suckling multiple lambs.

Section D gives practical guidelines to sampling feeds for analysis, interpreting analysis results and formulating rations to meet production requirements. A simple technique like the Pearson Square can be used to formulate basic rations. Computer software, designed specifically for the formulation of sheep rations, is more appropriate for routine use.

Finally, Section E suggests profit-oriented management practices based on the information contained in previous sections. The adoption of such practices is recommended for most producers. It is mandatory if the sheep flock is expected to produce a reasonable return on investment, management and labour. Livestock production today involves marginal economics and unless one is dealing with a "full-deck" of sound practices, economic survival may be impossible.

In summary, this guide attempts to integrate the whole area of sheep nutrition into a practical package for the profit-oriented producer.

SECTION A – FEEDS

The logical starting point for a discussion on animal feeding is the feed itself. Although some producers raise sheep because of their fondness for the animals, in most parts of the world sheep are raised because of their ability to utilize an otherwise unusable resource to produce food and fibre suitable for human consumption. Sheep are viewed merely as forage converters.

In fact, sheep (and other ruminant animals) are relatively inefficient in their conversion of feed to human food. The production of beef and lamb can only be economical when the costs of raw materials are low. For this reason sheep production is based on forage, either fresh, as pasture, or conserved, in the form of hay or silage. Except in the case of fast growing lambs, grain and other concentrates should only be viewed as supplements. These feeds are more efficiently utilized either by humans directly or through other animal production systems such as swine and poultry.

FEED COMPOSITION

The Growth of Forages

Forage growth is summarized in Figure A1. All green plants absorb carbon dioxide (CO_2) from the air through their leaves. Water (H_2O), nitrates and minerals are assimilated from the soil by the roots. *Sunlight*, which is trapped by the green pigment *chlorophyll*, provides the energy which is used by the plant to make carbohydrates, proteins and other organic constituents from these simple nutrients.

Carbohydrates

Carbohydrates are combinations of carbon dioxide and water. The simplest combinations are called sugars and include glucose, galactose, fructose and pentose. These substances are soluble in water and are readily transported through the plant to provide for a variety of requirements. Simple sugars are the building blocks for more complex carbohydrates such as cellulose, hemicellulose, pentosans and starch. Cellulose and hemicellulose are important constituents of plant cell wall. Hemicellulose, pentosans and starch are some of the forms in which plants store energy. These are often referred to as *carbohydrate reserves*, or in forages like alfalfa, *root reserves*. Starch is the carbohydrate which forms the kernel of feed grains.

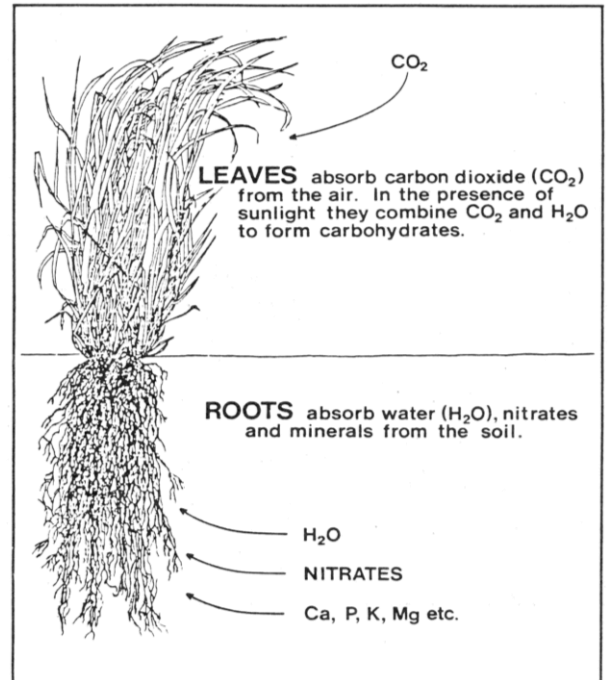

Figure A1 Forage Growth.

Fats and Oils

Like carbohydrates, fats and oils are made up of carbon, hydrogen and oxygen. However, the proportion of carbon and hydrogen is much greater with the result that fats and oils furnish 2.25 times as much energy per kilogram as do carbohydrates and proteins.

Plants, except for the oilseeds, contain relatively low levels of fats and oils. Unlike animals which store energy as fat, plants store energy as carbohydrate, as suggested above.

Lignin

The more fibrous parts of plants contain considerable amounts of *lignin* which is a very complex substance, somewhat similar to the complex carbohydrates. It is important in giving plants some of their structural properties, but as we will see later, is of little value as a feed constituent.

Proteins

In addition to carbon (from CO_2), hydrogen (from H_2O) and oxygen (from both), plant proteins contain nitrogen and many contain sulfur and phosphorus assimilated from the soil. These compounds are almost infinite in nature mainly functioning in plants in the form of *enzymes*. Proteins are predominantly

found in the reproductive parts and in actively growing portions such as leaves. In animals, of course, protein is found mainly in the form of muscle tissue. Of particular importance in sheep production, wool is also composed of protein. Since these constitute the end-products of the sheep enterprise, it is easy to appreciate the importance of protein in the feed.

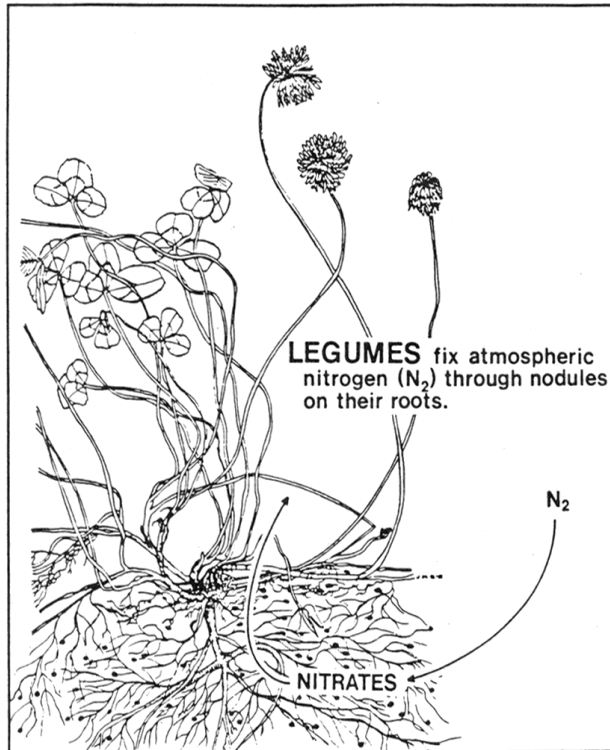

Figure A2 Nitrogen fixation in legumes.

Legume forages generally contain higher levels of protein than the grasses. This is due to the large supply of nitrogen available to them through fixation from the atmosphere. Nitrogen fixation is facilitated by bacteria contained in nodules on the roots which transfer the nitrogen to the plant (fig. A2). In exchange, the legume plant supplies soluble carbohydrates which provide energy to the bacteria.

Minerals

Plants assimilate minerals from the soil through their roots. Although present in relatively small amounts, they are as essential to the development of the plant as they are to the animals which consume them. Minerals are well distributed in the plant, largely occurring in association with the organic compounds (carbohydrates, proteins, fats and oils). For example, magnesium is an essential component of chlorophyll.

Vitamins

Like the other organic compounds, plants synthesize vitamins from raw materials absorbed through their roots and leaves. Some of them, like the B-vitamins serve much the same functions in plants as they do in animals. Others serve a specific function in plants which is quite different from their function in animals. For example, carotene is a yellow plant pigments which plays a part in photosynthesis. Animals convert carotene to vitamin A which is essential in maintenance of tissue surfaces.

FEED ANALYSIS

Chemical analysis of feed is aimed at estimating its nutritional value for livestock. The analyses have their limitations and a brief description of the methods used will provide an understanding of how the results can be used to best advantage. Reference to the feed analysis report shown in figure A3 will assist in putting the discussion into perspective.

Dry Matter (Line 1)

The amount of moisture contained in feeds is widely variable. Hay and grain usually contain about 10% moisture. Silage may contain 50-75%. Pasture plants are often 80-85% water. In most feeding situations, animal intake is limited only by the dry matter content of a feed. In other words, a ewe who is capable of consuming 2kg (4.4 lbs) of leafy grass hay (10% moisture: 90% dry matter) will also be capable of consuming 9kg (19.8 lbs) of leafy grass pasture (80% moisture: 20% dry matter). In both cases she will consume 1.8kg (4 lbs) of dry matter. Expressing feed analysis, animal intake and nutrient requirements on a dry matter basis eliminates moisture as a variable in the comparison of different feeds and in the calculation of balanced rations.

Dry matter content (%DM) may also provide information about the storage properties of feed. Extra moisture may result in heating and spoilage in hay and grain. Inadequate moisture in silage may result in poor preservation while a high moisture content may lead to excessive nutrient leaching. However, for these purposes dry matter content should be measured before the feed is stored. Analysis results from the feed lab are usually received too late for remedial action to be taken.

On the feed analysis report, dry matter is expressed as a percentage. The figure is derived by simply weighing a sample of feed before and after drying at 70-80° C:

$$\% \text{ DM} = \frac{\text{dry weight}}{\text{wet weight}} \times 100$$

Lines 2 to 5 of the feed analysis report express results both “as fed” and “dry”. The two figures are related as follows:

$$\% \text{ as fed} = \% \text{ dry} \times \frac{\% \text{ DM}}{100}$$

Fibre (ADF) (Line 1)

ADF stands for acid detergent fibre. This analysis estimates the amount of low digestibility material in a feed by boiling a weighed sample in an acid detergent solution. The residue which remains undissolved consists primarily of lignin, cellulose which is associated with it, and silica. Cellulose digestibility is dependent on the degree to which it is lignified. This will be discussed later under Carbohydrate Digestion.

$$\% \text{ ADF} = \frac{\text{residue}}{\text{original sample}} \times 100$$

Total Digestible Nutrients (Line 2)

Since ADF estimates that proportion of the feed which is low in digestibility, it is not surprising that this figure can be used to estimate, by difference, that proportion which is digestible. Accordingly, total digestible nutrients (TDN) is calculated from ADF using the following equations:

grass forage:
 $\% \text{ TDN} = 104.95 - 1.30 \times \% \text{ ADF}$

legume forage:
 $\% \text{ TDN} = 92.70 - .97 \times \% \text{ ADF}$

mixed grass-legume forage:
 $\% \text{ TDN} = 97.66 - 1.13 \times \% \text{ ADF}$

corn silage:
 $\% \text{ TDN} = 77.44 - .45 \times \% \text{ ADF}$

concentrates:
 $\% \text{ TDN} = 88.94 - .66 \times \% \text{ ADF}$

In British Columbia, TDN is used as an estimate of the energy content of feed, since any of the organic constituents of feed, including protein, will provide energy when digested. Other areas of North America use *Digestible Energy (DE)* while the United Kingdom, New Zealand and Australia use *Metabolizable Energy (ME)* in the description of feed

energy. These three sets of terminology are simply related for practical purposes as follows:

$$\text{DE (in megacalories/kg)} = \% \text{ TDN} \times .044$$

$$\text{ME (in megajoules/kg)} = \% \text{ TDN} \times .15$$

The terms digestible energy and metabolizable energy are related to the energy partition concept shown in figure C2 (p.19). In practice, the contributions of a particular feed to each of these several energy categories can only be measured in animal feeding trials under strict experimental conditions. Until more practical techniques can be developed to do this, we will continue to use the simplistic (if less accurate) methods described above.

Protein (Line 3)

In the discussion on feed composition it was noted that protein contains a significant proportion of nitrogen, setting it apart from the other organic constituents found in feeds. On this basis, the chemical analysis for protein (the Kjeldahl method), measures only the total amount of nitrogen in a sample. The *crude protein (CP)* level is then calculated, knowing that protein contains an average 16% nitrogen:

$$\% \text{ CP} = \frac{\% \text{ nitrogen}}{0.16}$$

Although this method accurately measures nitrogen, the extrapolation to crude protein is subject to error. Proteins in different feeds vary in their nitrogen content as shown in table A1. In addition, some of the nitrogen present may not be associated with available protein as in:

1. heavily fertilized pastures;
2. forages which have accumulated nitrates;
3. mouldy hay; and
4. heat damaged silage, hay or grain.

TABLE A1 The percentage of nitrogen in proteins from various feeds.

Protein Source	% Nitrogen in Protein
Forage Leaves.....	15.0
Barley Grain.....	17.2
Corn Grain.....	16.0
Oilseed Meals.....	18.5
Fishmeal.....	16.0
Milk.....	15.8

The level of unavailable nitrogen in heat damaged forages can be estimated using a combination of two analyses which have been described above. The residue from the ADF procedure is subjected to a nitrogen analysis giving the *acid detergent insoluble nitrogen* (ADIN) as a percentage of total nitrogen. The significance of protein degradability will be more fully discussed later (p. 13).

Minerals (Line 4 to 9)

As stated earlier, most of the minerals found in plants are associated with organic compounds. Mineral analysis involves burning a sample of the feed, leaving an ash in which the minerals are present as simple inorganic (no carbon) salts. The ash is subsequently analyzed for each element specifically.



Testing Lab

Certificate of Analysis

Testing Labs
Various Locations
Alberta, AB
Phone: (403) 234-5678
Fax: (403) 234-5679

Lot Number: 123456
Report Number: 789101
Sample ID: 12131415
Page: 1 of 1

Date Received: Oct 20,2003
Date Reported: Oct 24,2003
Sample Retained: Nov 19, 2003
Sample Received Via: Courier
Arrival Condition: Good

Bill to: Joe Shepherd
Phone # : (250) 234-5678
Comp 1 Site 3 RR#3
Upper Cutbank, BC, V2Z 0X0

Feed Analysis

Producer	Client Sample ID	Client Sample Code	Client Comments
Shepherd	PEW1004	PEWD2	16/10/02

Sample Code	Client Sample Description
Grass Hay	Hav ** Local ** 3rd Cut ** LM

ANALYSIS	UNITS	RESULT	ANALYSIS	UNITS	RESULTS
1 DRY MATTER	%	88.9	ACID DETERGENT FIBRE	%	37.7
2 TDN AS FED	%	49.6	TDN DRY	%	55.8
3 PROTEIN AS FED	%	9.5	PROTEIN DRY	%	10.7
4 CALCIUM AS FED	%	0.41	CALCIUM DRY	%	0.46
5 PHOSPHORUS AS FED	%	0.21	PHOSPHORUS DRY	%	0.24
6 POTASSIUM	%	2.31	MAGNESIUM	%	0.21
7 IRON	ug/g	235	MANGANESE	ug/g	119
8 ZINC	ug/g	26	COPPER	ug/g	9.8
9 MOLYBDENUM	ug/g	3.6	SELENIUM	ug/kg	22
10 SILAGE pH	pH		BUSHEL WEIGHT	1b/bu	

Figure A3 Feed analysis report.

Notice on the feed analysis report that calcium, phosphorus, potassium and magnesium are given as percentage figures with iron, manganese, zinc, copper and molybdenum are reported as mg/g (micrograms per gram) and selenium as ug/kg (micrograms per kilogram). This is simply a reflection of the fact that some minerals are found in plants in relatively large amounts while others are present in only *trace* quantities.

1%	= 1 part per hundred
1 mg/kg	= 1 part per million (ppm)
1 ug/kg	= 1 part per billion (ppb)

Later, in the section on specific nutrient requirements, minerals will be divided into macromineral and trace or micromineral categories. This is not meant to imply that the minerals required in trace quantities are any less important than those required in larger quantities.

Mineral levels given on the feed analysis report cannot be considered in isolation, since many of the elements interact with one another, affecting availability. For example, a copper level of 8 mg/kg might appear adequate with reference to the requirement tables in Appendix II. However, if the molybdenum level is more than 2 ug/g, the availability of copper to the animal may be limited.

It is possible to obtain analyses for several important minerals not listed on the feed analysis report. In particular, potassium, sulfur, molybdenum and selenium may be included upon request.

Silage pH (Line 10)

The proper preservation of silage is dependent upon its moisture content and acidity. The latter is measured on the scale of pH. Pure water has a pH of 7. A pH of 6 indicates a low level of acidity while pH 5 is ten times as acidic as pH 6 and pH 4 is again ten times as acidic as pH 5.

High moisture silage (60-75% moisture; 25-40% DM) should have a pH below 4.5. The pH of haylage or low moisture silage may be slightly higher. Of particular interest to sheep producers, poorly preserved silage is often related to outbreaks of Listeriosis or circling disease. When high moisture forage is not well chopped prior to ensiling, it is impossible to eliminate sufficient air when packing. Improper fermentation results in a pH which is too high providing good conditions for the proliferation of the bacteria which cause the disease.

Bushel Weight (Line 10)

Figure A4 shows the relationship between bushel weight (bulk density) and % TDN for the common feed grains. The same correlation exists between bushel weight and % CP, but the magnitude of variation in CP content is much smaller. These relationships arise from the fact that the grain kernel is denser than the hull and also higher in digestible nutrients (mainly starch). The practical implication of this relationship is very useful when a producer is buying grain without the benefit of a feed test. Light grain (eg. 32 lbs/bushel) is worth less than heavy grain (eg. 48 lbs/bushel). Bushels can be converted to gallons or litres as follows:

$$1 \text{ bushel} = 7.78 \text{ gallons} \\ = 35.36 \text{ litres}$$

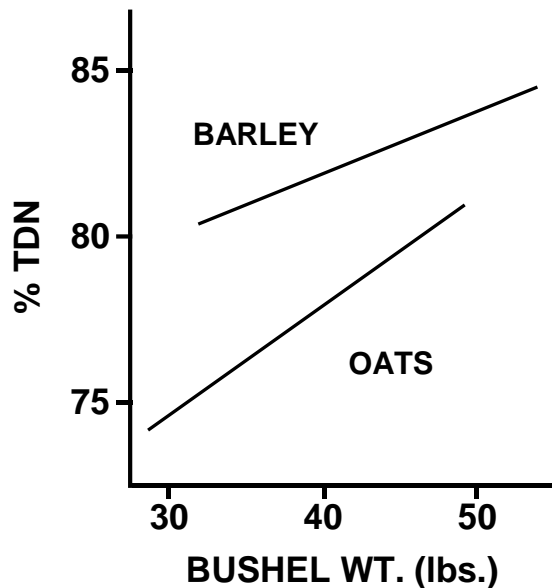

Figure A4 The relationship between bushel weight and % TDN.

NEAR INFRARED REFLECTANCE (NIR) SPECTROSCOPY

NIR is a quick, reliable, low cost, computerized method used to analyze feeds for their nutrient content. It uses infrared light instead of chemicals to identify important compounds and measure their amounts in a sample. Feeds can be analyzed in less than 15 minutes using NIR. Chemical methods may take hours or days. This quick turn around and the resultant cost savings in labour make NIR an attractive new method of analysis. Some feeds and certain nutrients cannot be tested by this method because it is relatively new.

FACTORS AFFECTING FEED QUALITY

Several factors which affect the feed test have already been mentioned. The energy content of feed grain is directly proportional to bulk density (bushel weight). Heating in storage reduces protein availability in hay and silage. Improper preservation of silage results in lower energy and protein values. In addition to these, stages of maturity, legume content and weathering can have significant effects on forage quality.

TABLE A2 The effect of maturity on the feeding value of forages.

Stage of Maturity at Harvest	% TDN	% Crude Protein Intake		% of BW
		grass	legume	
Vegetative	63	15	21	3.0
Boot or Bud	57	11	16	2.5
Bloom	50	7	11	2.0
Mature	44	4	7	1.5

Table A2 shows the effect of maturity on the feeding value of forages. In grasses, the boot stage occurs when the immature seed head emerges out of the sheath of the youngest leaf. After this, feed quality declines rapidly. The same occurs in legumes after the bud stage. It is, of course, impractical to harvest forages at these very early stages since yields will be relatively low. The optimum time for harvest is a compromise between quality and quantity as shown in figure A5. The target should be maximum nutrient yield per acre rather than simply maximum forage yield.

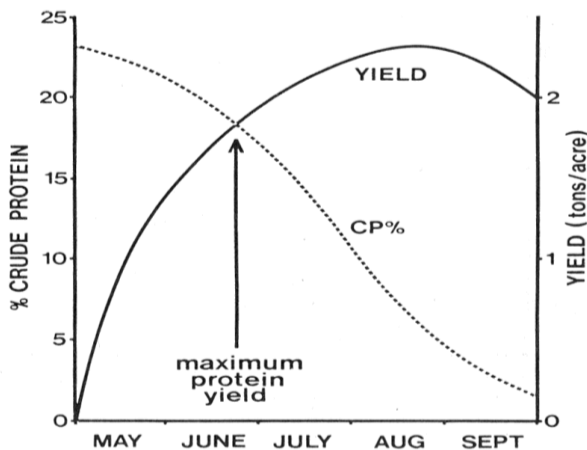

Figure A5 The effect of maturity on forage yield & quality.

Table A2 also points out differences in protein content of grasses and legumes. Forages which have significant legume content have higher feeding values than those containing grasses alone.

Finally, it should be obvious to anyone with experience in making hay that weathering, either in the swath or in the stack can reduce feed quality. Table A3 relates protein loss to amount of rain when making hay and also points out the effect of leaf shedding.

TABLE A3 The effect of haymaking conditions on protein loss.

Haymaking Conditions	% Loss of Protein
Barn dried, no rain	14
Field dried, no rain, some leaf loss	33
1-2 rainshowers	28
5-6 rainshowers	50

Since leaves are significantly higher in nutrient content at all stages of maturity (fig. A6), it is not surprising that leaf loss leads to lower forage quality. This is particularly prevalent when legumes are harvested under very dry conditions.

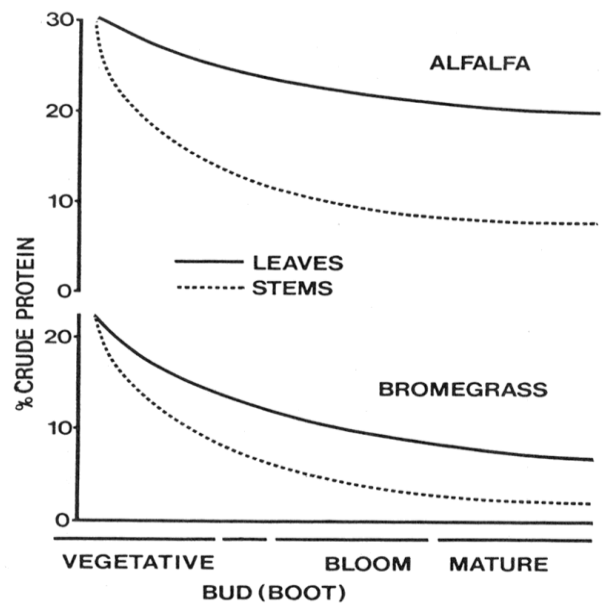

Figure A6 Leaves are higher in nutrient content than stems at all stages of maturity.

BRITISH COLUMBIA FEEDS

Appendix I gives average analyses of typical B.C. feeds. These are not intended as a substitute for feed analysis of the specific feeds available to an individual producer. The nutrient levels of forages, in particular, are extremely variable and consequently the values in Appendix I can only be considered benchmarks. Preparation and submission of feed samples are discussed in a later section (p. 43).

SECTION B – THE DIGESTION OF FEED

Earlier, it was pointed out that ruminants are relatively inefficient in the conversion of feed. The suggestion was made that the production of lamb (and beef) could only be economical when feed costs are low. Thus, economics dictate that sheep production be forage-based. The ability of sheep and ruminants in general, to utilize forage is a function of their unique digestive system.

The digestive systems of mammals are broadly divided into two classes:

1. *Monogastric* – meaning one stomach, includes: human, horse, pig
2. *ruminant* – includes: sheep, cattle, goats, deer, bison

In order to understand some of the unique properties of the ruminant system, it will be helpful to briefly discuss the simpler *monogastric* system.

MONOGASTRIC DIGESTION

An outline of the human system is shown in figure B1. Food, upon entering the mouth, is subdivided by chewing. At the same time lubricating digestive juices containing *enzymes* are secreted from the salivary glands. These particular enzymes are responsible for initiating the breakdown of *starches*.

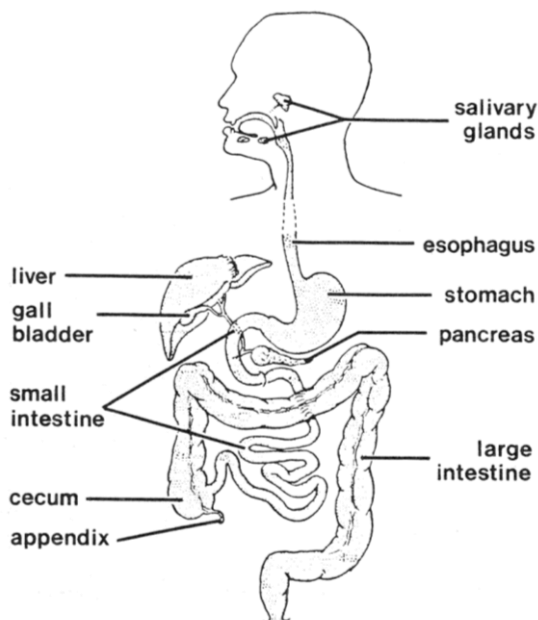

Figure B1 The human digestive system.

TABLE B1 A comparison of the relative sizes of digestive tract compartments in adult animals.

Digestive Compartment	Volume as % of Total Digestive Tract				
	Cattle	Sheep	Horse	Pig	Human
Rumen	56.9	52.9			
Reticulum	2.1	4.3			
Omasum.....	5.3	1.7			
Abomasum.....	6.5	7.7			
Total Stomach	70.8	66.6	8.6	29.2	18.8
Small Intestine ..	18.5	20.5	30.2	33.3	62.4
Cecum	2.8	2.6	15.9	5.6	
Large Intestine ..	7.9	10.3	45.3	31.9	18.8
Total Capacity (litres)	356.0	44.0	211.0	28.0	6.0

Food, now mixed with these secretions, passes down the esophagus into the *stomach*, where the digestion of protein, fats and oils is initiated by acid and other specific enzymes. In monogastrics, the stomach also serves as a reservoir for food which has been rapidly ingested.

When the initial stages of digestion in the stomach are completed, the contents pass into the *small intestine*. Here, bile from the liver and gall bladder, as well as enzymes from the pancreas are added. Breakdown continues as the digesta travel the 10-20 meter length of the small intestine, while at the same time the products of digestion are absorbed into the bloodstream.

Enzymatic breakdown of most of the organic constituents of food is complete by the time the unabsorbed digesta reach the *large intestine*. One of the main functions of this part of the system is the absorption of water and minerals of both dietary and secretory origin. In addition, further breakdown is carried out here by a permanent population of microbes (bacteria and protozoa) with some proportion of the products being absorbed into the blood. Food material which has escaped both enzymatic and microbial digestion is excreted.

Some monogastrics, like the horse and rabbit, have a relatively large capacity for microbial digestion in the large intestine and cecum. Table B1 compares the size of several parts of the monogastric digestive system. Notice that where the large intestine and cecum make up only 19% of the digestive system in the human, they represent over 60% of the total volume in the horse. The implications of this will become clear when we discuss microbial digestion in the ruminant.

THE SHEEP'S DIGESTIVE SYSTEM

The main feature which distinguishes our own digestive system from that of the sheep is the complex stomach shown in figure B2. The first two sections, the *rumen* and *reticulum* comprise a large fermentation compartment. Ingested feed passes rapidly, with very little chewing, down a muscular esophagus into the rumen. Later, boluses (cuds) of feed are regurgitated, broken down by chewing and mixed with saliva. The sheep, in fact, produces large volumes of saliva, perhaps up to 25 litres per day. The absence of adequate fibre in the ration to permit cud formation may account for the wool picking and wood chewing which is sometimes seen in feedlot lambs on concentrate rations.

On entering the rumen, feed is immediately subjected to microbial digestion. An extremely varied population of bacteria and protozoa (fig. B3) attach themselves to the feed and begin the breakdown process. This is facilitated by the secretion of enzymes onto the feed and into the fluid contents of the rumen. It should be noted that the microbial population which becomes attached to a particle of grain will be quite different from that which attaches to a forage leaf. This has important implications when changes in ration are contemplated (p. 51). A slow transition is necessary to allow time for alternations in microbial populations.

The lining of the rumen is like pile carpet having innumerable small, flat projections called papillae. These serve two main functions. They vastly increase the area for absorption of nutrients and they also provide attachment sites for additional populations of bacteria. Figure B4 is an electron photo-micrograph of bacteria attached to rumen papillae. These bacteria, like the ones attached to feed particles, produce enzymes which are secreted into the fluid contents of the rumen. One of the important contributions of this particular population is the enzyme *urease* which is responsible for the breakdown of urea. Feed, then, is subjected to digestion both by enzymes dissolved in the general milieu of the rumen and, more specifically, by those produced by attached microbes.

Continual mixing of rumen contents is essential to efficient fermentation. The muscular walls of the rumen and reticulum produce waves of contraction traveling their combined lengths at about half-minute intervals. This process, in addition to mixing the rumen contents, facilitates both regurgitation for further "cud-chewing" and belching, which releases gases produced by fermentation (mainly hydrogen and methane). Under some conditions (eg. grain overload) the muscular walls may stop contracting resulting in *rumen stasis*, which can place the animal at serious risk of bloating.

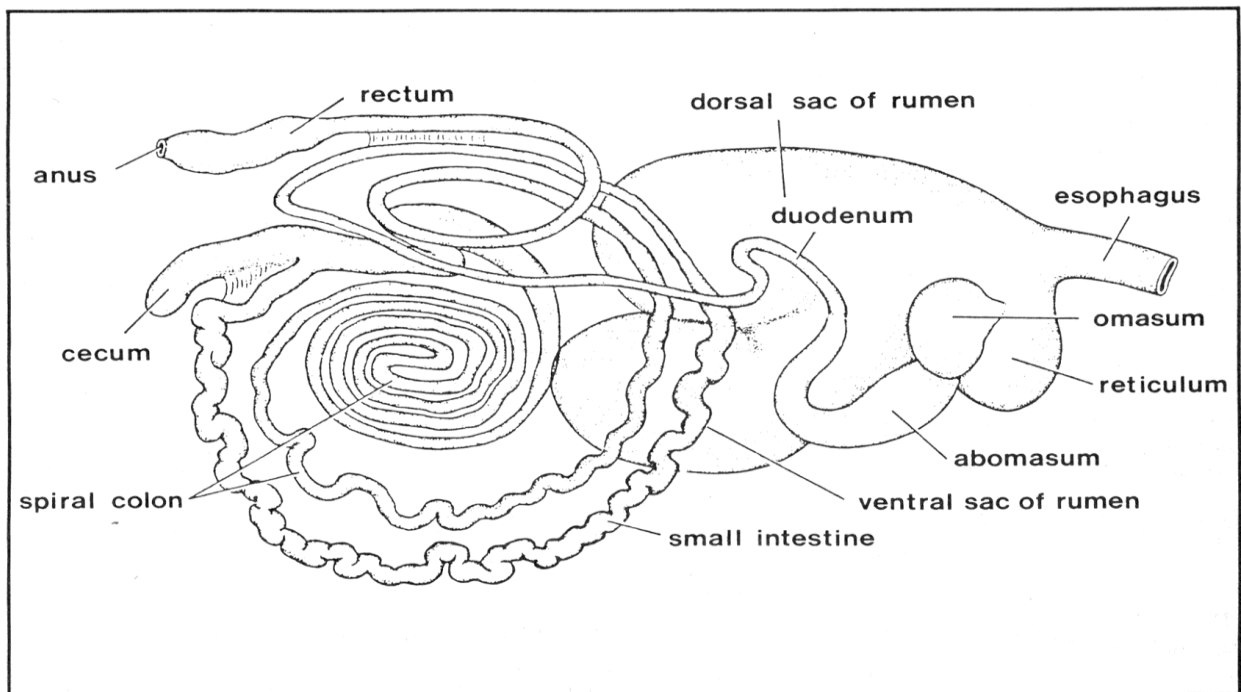

Figure B2 The digestive system of the sheep.

After the feed has been sufficiently chewed and broken down by microbial action, the digesta enters the *omasum*. Flow into this third segment of the ruminant stomach is regulated by a small opening called a *reticulo-omasal orifice* which prevents large particles from leaving the rumen. It is the small caliber of this orifice which makes it possible for sheep to utilize whole grains. The larger orifice in cattle allows particles the size of whole grain to pass into the lower gut and be excreted.

The omasum itself is a muscular organ which is thought to have two main functions. The first is the extraction of water from the rumen fluid yielding a product for further digestion which has a significantly higher proportion of dry matter. Secondly, the omasum serves as a pump, propelling digesta from the rumen and reticulum into the fourth segment of the stomach, the abomasum.

The ruminant *abomasum* is analogous to the true stomach of the monogastric with its digestive processes being very similar to those described earlier for the human. Digestion and absorption of its products progress as the digesta passes down the *small intestine*.

The large intestine and *cecum* of the sheep represent only about 12% of the total volume of its digestive system. This may seem quite insignificant

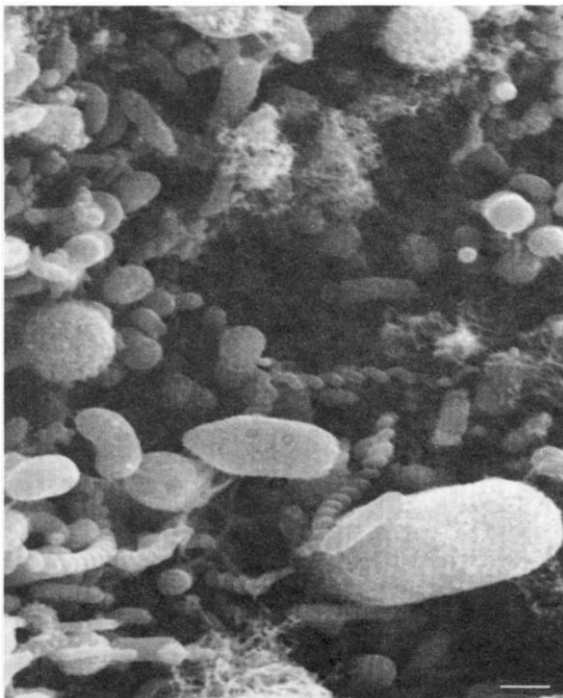

Figure B3 The varied population of bacteria and protozoa found attached to feed particles in the rumen and reticulum.

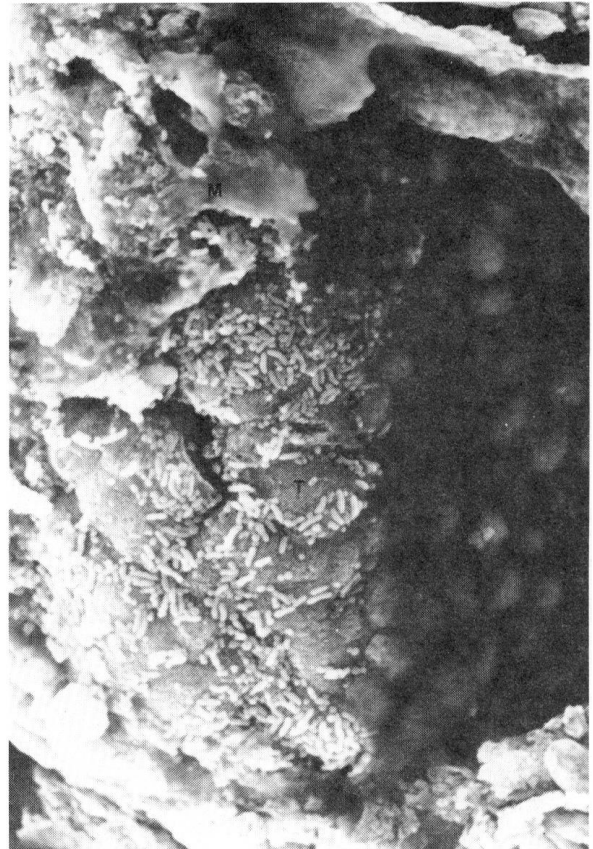

Figure B4 Bacteria attached to the lining of the rumen.

in comparison with the horse (table B1). However, fermentation in this area can make a significant contribution to overall digestion. This will be discussed further in the section on Carbohydrate Digestion (p. 12).

Development of the Ruminant Stomach

At birth, the lamb's rumen and reticulum have a capacity roughly equal to that of the abomasum (fig. B5). They contain no micro-organisms and, as a consequence, are not capable of functioning as they do in the adult. Bacteria begin to populate the rumen shortly after birth as the lamb begins to nurse and explore its environment. However, it takes several weeks before a stable microbial population is established which is capable of efficient digestion.

Scientists at Agriculture and Agri-Food Canada's Lethbridge Research Station have attempted to hasten the establishment of functional microbial populations in newborn lambs. There are two reasons for this. First, many of the bacteria which contaminate the digestive tract from the environment early in life are capable of producing digestive upsets such as scours.

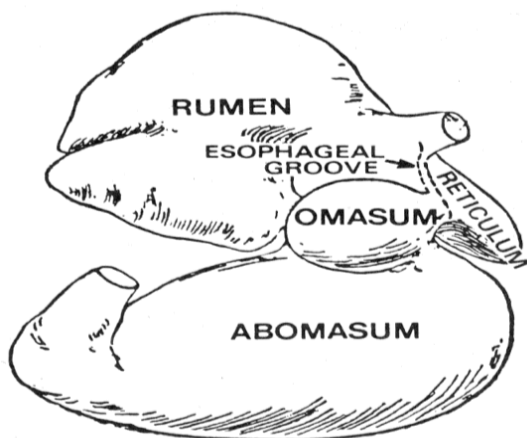

Figure B5 The stomach of the newborn lamb.

By inoculating the rumen and reticulum with a more appropriate microbial population, the digestive tract can be protected from the adverse effects of such contaminants through competition.

The second reason for attempting to establish a functional population is to hasten the ability of the rumen and reticulum to digest solid feed. This would make it possible to wean lambs earlier, a particular advantage when accelerated lambing is being attempted.

The Esophageal Groove

Since the rumen and reticulum are non-functional in the newborn lamb, a mechanism has evolved which allows milk to flow directly to the omasum. A reflex reaction causes a muscular fold on the wall of the reticulum to form a closed tube leading from the end of the esophagus to the reticulo-omasal orifice (fig. B5). This fold is called the *esophageal groove* and an appreciation of its function will affect some of the management aspects of feeding newborn lambs.

The esophageal groove closes in response to behavioural stimuli associated with the ingestion of liquid feed such as nursing from the ewe or feeding from a nipple pail. Even the sight of a nipple bottle may elicit the response in an orphan lamb. The reflex, however, requires some degree of training. Therefore, it is used to best advantage when feeding routines are well established.

If at all possible, weak newborn lambs should be encouraged to suckle either from the ewe or from a bottle. Although feeding by stomach tube may be the only alternative in many cases, this will invariably result in milk being deposited in the reticulum. A similar situation arises when milk is ingested too rapidly to be accommodated by the

esophageal groove. This can occur when milk replacer is fed from a bottle or from the bottom of a nipple pail where a round-holed (rather than a cross-cut) nipple is used.

Milk which finds its way into the rumen and reticulum is subjected to fermentation by bacterial contaminants early in life. Such fermentation may result in significant gas production resulting in a typical pot-bellied lamb. The young lamb cannot expel this gas efficiently since the belching mechanism is poorly developed.

Lambs being fed through a rubber nipple should be encouraged to suck. Frequent feedings of small volumes are usually more successful than large volumes fed infrequently. These management considerations are discussed in more detail later (p. 53).

Effect of Feeding Management

Between birth and maturity, the rumen and reticulum increase tenfold in volume in relation to the abomasum; the rate at which this proceeds can be significantly altered by nutritional management.

Most newborn lambs show little interest in consuming solid feed before they are two or three weeks of age. Consequently, until that time they must be nourished exclusively by milk or milk replacer. After this time it is possible to accelerate rumen development through feeding practices.

The closure of the esophageal groove only occurs when liquid feed is ingested. Therefore when solid feed is consumed it travels directly to the rumen where it is fermented to produce *volatile fatty acids* (see section on Carbohydrate Digestion, p.12). The presence of volatile fatty acids (VFA) has a direct effect on rumen development and, furthermore, higher rates of VFA production will accelerate this development. These observations have a direct bearing on management practices in feeding young lambs.

Creep feeding has become common practice in most successful sheep operations. The aim is to provide palatable, high quality solid feed to encourage consumption as early in life as possible. Restriction of milk intake after solid feed consumption is well established. This further promotes the intake of creep ration. The higher the quality and the greater the quantity consumed, the higher will be the rate of VFA production and the more rapid will be the rate of rumen development. Creep feeding is an essential practice in maximizing

lamb growth potential through increasing the ability of the lamb to consume nutrients. It also facilitates early weaning in accelerated lambing systems.

CARBOHYDRATE DIGESTION

As pointed out earlier, forages contain only low levels of fats and oils. Consequently, the main sources of energy for the ruminant are the *carbohydrates*.

Monogastric Carbohydrate Digestion

Carbohydrate digestion in the monogastric begins when food is mixed with saliva containing enzymes which begin the breakdown of starch. The process continues in the small intestine, facilitated by enzymes secreted by the pancreas. As digestion progresses, the end products (the simple sugars: glucose, galactose, etc.) are absorbed into the bloodstream. Depending on the energy status of the animal the sugars may be used as immediate energy sources or stored for later use. In the lactating female, glucose is used in the manufacture of the milk sugar, lactose.

Ruminant Carbohydrate Digestion

The enzymes which mediate carbohydrate breakdown in the ruminant are mainly of microbial origin. Each of the several classes of carbohydrates is digested by specific enzymes produced by a distinct microbial population (fig. B6).

Volatile Fatty Acids

If oxygen were present in the rumen, the end-products of carbohydrate digestion would be carbon dioxide and water, the compounds from which the carbohydrates were originally synthesized in the plant (p. 2). However, the microbial population in the rumen operates in the absence of oxygen (the rumen environment is *anaerobic*), resulting in incomplete carbohydrate breakdown. Under these conditions, the principal end-products of digestion are compounds referred to as the volatile fatty acids (VFA's), including acetic acid, propionic acid and butyric acid. Incomplete breakdown in this case is analogous to the situation where wood is burned with limited air. The smoke produced is composed of the products of incomplete combustion.

The breakdown of carbohydrates to VFA's results in the release of significant amounts of feed energy. This energy is utilized in the rumen from microbial growth involving, for example, the synthesis of new microbial protein, fat and carbohydrate. The VFA's are absorbed into the bloodstream through the wall

of the rumen to serve as energy sources for the sheep itself.

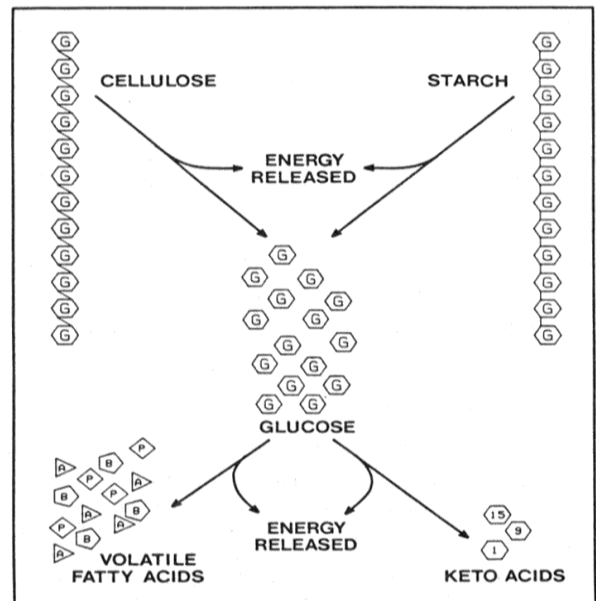

Figure B6 Volatile fatty acids are the main end products of carbohydrate digestion in the sheep.

Other important products of ruminant carbohydrate digestion are the *keto acids*. These are formed in much smaller quantities than the VFA's, but serve an important role in microbial protein synthesis (p. 15).

Carbohydrates which escape digestion in the rumen and those associated with the microbial population may be utilized further down the digestive tract. For example, carbohydrates which are components of microbial cells are digested and the resulting sugars absorbed in the small intestine, as in monogastrics. The contributions of these simple sugars to the overall energy requirements of the sheep are minor.

Further carbohydrate breakdown may also occur in the large intestine. Experimental results suggest that 5-10% of the energy requirement of lambs could be met from VFA's produced by the microbial population found here.

Cellulose Digestion

The microbial populations of both the rumen and the cecum produce the enzyme cellulase which is responsible for the breakdown of cellulose. It is this feature which makes ruminants and monogastrics like the horse unique in their ability to utilize forages in the production of meat, milk and fibre. Mammals are incapable of digesting cellulose without the aid of these microbes. Several features of cellulose

utilization should be appreciated when feeding sheep.

The digestion of cellulose is a relatively slow process (fig. B12). One implication of this is the fact that feed consumption is limited by the rate at which feed is digested. Feed can be introduced into the rumen only as rapidly as the products of digestion are discharged. In practical terms this means that rations high in fibre (ADF) may be consumed in lower quantity than those which are low in fibre.

A second consideration is the degree to which the cellulose in a feed is associated with lignin. As forages mature, the cellulose found in plant cell walls becomes more lignified. The result is that the cellulose becomes less digestible. This is reflected in higher ADF and lower TDN values for forages as they mature (table A2). Several chemical treatments of low quality (high ADF) forages have been developed which essentially break the association between cellulose and lignin. One of the more successful has been the treatment of straw with gaseous ammonia. In addition to increasing the digestibility of cellulose, this treatment increases the crude protein level of the end product.

Other Carbohydrates

Starch, pentosans, hemicelluloses, and sugars are rapidly fermented in the rumen to produce VFAs, CO₂, keto and lactic acids. Under most conditions, lactic acid production is low. However, when feeds containing large quantities of readily fermented carbohydrates are rapidly consumed, lactic acid production may be significant. As a result, the level of acidity in the rumen may rise (pH decreases). Since the level of acidity (pH) is critical to proper rumen function, rapid changes can cause digestive problems. For example, grain overload results in decreased rumen pH which leads to rumen stasis (p.9). The animal becomes unable to expel gases by belching and bloat occurs.

One of the main advantages of feeding whole grain to sheep lies in the reduced rate of fermentation since the starch is not as immediately available to microbial breakdown as it is in the milled grain. This results in a more prolonged digestion accompanied by a stabilization of rumen pH. The effects are also seen in the health of the rumen papillae (fig. B7).



Figure B7 Whole grain feed permits the maintenance of healthy rumen papillae shown above. Prolonged feeding of milled grain may produce papillae like those shown below.

PROTEIN DIGESTION

Proteins, as suggested earlier, contain carbon, hydrogen, oxygen, nitrogen, usually sulfur and sometimes phosphorus. In order to understand how proteins are digested, a further explanation of their nature is required.

Amino Acids

Each different protein consists of a specific combination of 20 amino acids. In turn each amino acid contains a single atom of nitrogen in combination with two atoms of hydrogen called an amino group (NH₂). Not all proteins contain all amino acids. These concepts are illustrated in figure B8.

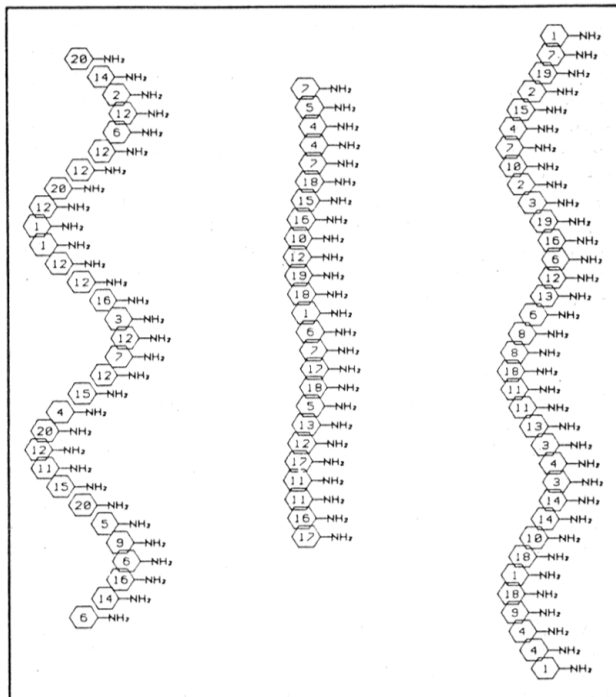

Figure B8 Proteins are composed of long chains of amino acids. Each different protein has a specific sequence of amino acids and a unique shape.

Monogastric Protein Digestion

When protein is digested by the monogastric animal (fig. B9), the long chains are first broken down into shorter chains called peptides, a process which begins in the stomach. In the small intestine, further digestion releases the individual amino acids which are absorbed into the bloodstream.

The monogastric now uses these absorbed amino acids as building blocks for its own particular types of protein.

Protein Quality

Because the animal has specific requirements for amino acids to be incorporated into its own proteins, the concept of *protein quality* arises. If the balance of amino acids in the feed protein is very similar to that required by the animal, the protein is said to be of high quality (table B2).

TABLE B2 Quality comparison for proteins from various sources. Protein quality is expressed in terms of relative biological value.

Protein Source	Protein Quality
Grass Forage.....	38
Legume Forage.....	52
Corn Grain.....	58
Wheat Grain.....	59
Canola Meal.....	62
Mixed Microbes	65
Soyameal.....	70
Oats Grain	70
Barley Grain.....	72
Fishmeal.....	77
Milk.....	87
Egg.....	99

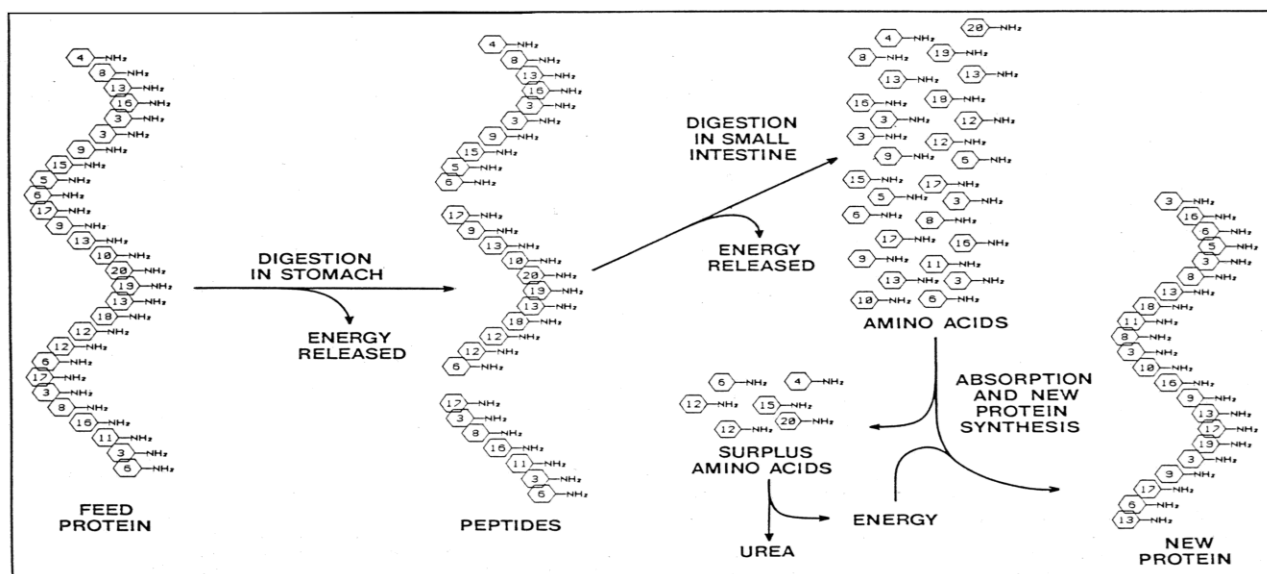

Figure B9 Protein digestion in the monogastric animal.

If the amino acid composition of feed proteins is poorly matched to requirements, the protein is of *low quality*. Surplus amino acids are broken down in the liver and kidney. The amino group is removed and may be recycled or excreted in the form of urea in the urine while the remainder of the molecule is utilized as an energy source.

Ten of the 20 amino acids can be manufactured by mammalian tissues as long as a source of nitrogen is available. For this purpose nitrogen may be obtained from urea or from the amino groups of surplus amino acids. The remaining 10 *essential* amino acids must be supplied in the diet of the monogastric animal. It is the availability of these essential amino acids which usually limits the synthesis of animal proteins. For example, when corn is fed to pigs, the limited availability of the essential amino acid lysine usually restricts growth. When corn-based rations are supplemented with lysine, a significant improvement in feed conversion efficiency occurs.

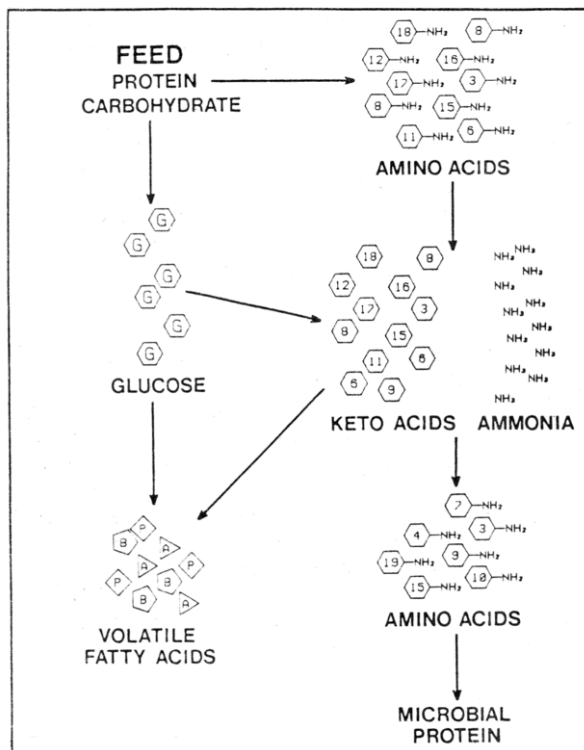

Figure B10 Protein digestion in the sheep.

Ruminant Protein Digestion

Protein digestion in the ruminant is much more complex than that in the monogastric. Plant proteins enter the rumen and reticulum where they are attacked by the microbial population and broken down to their constituent amino acids. However, microbial *degradation* does not stop here. Most of

these amino acids are further degraded, resulting in the release of the amino group which, when combined with a third hydrogen atom, forms ammonia (NH₃) as shown in figure B10. As was the case in carbohydrate digestion, protein degradation releases energy.

Ammonia in the rumen can also be derived from non-protein nitrogen (NPN) sources. Mention was made earlier of the large quantities of saliva produced by the sheep. This saliva serves as a vehicle for recycling amino groups in the form of urea (fig. B11) back into the digestive system from amino acid breakdown elsewhere (eg. liver). Urea may also be included in the feed as an inexpensive source of crude protein. Urea is broken down in the rumen by the enzyme urease and its amino groups are released as ammonia. Reference has already been made to the fact that the bacterial population adherent to the rumen papillae is a major contributor of urease (p. 9). The practical implications of this will be discussed later.

The first stage of nitrogen digestion in the sheep is completed with the production of amino acids and ammonia accompanied by the release of energy. The second stage involves the use of these products by the bacteria and protozoa in the rumen to build new microbial protein. This process, illustrated in figure B10, requires recapturing some of the energy released in the first stage as well as energy released from carbohydrate breakdown. The keto acids released during both protein and carbohydrate digestion are combined with ammonia to form new amino acids and, subsequently, new microbial protein.

Having completed the processes of plant protein degradation and microbial protein synthesis, micro-organisms are drawn through the omasum and into the abomasum. Here the digestion of microbial protein begins in a manner similar to that in the monogastric. Digestion continues in the small intestine with amino acids being absorbed into the bloodstream to provide building blocks for animal protein as before.

Since the microbial population in the rumen has the capacity to synthesize essential amino acids, proteins considered "low quality" for monogastrics are actually improved by the rumen microbes. On the other hand "high quality" proteins are also modified with the result that the protein reaching the small intestine is of a relatively uniform medium quality irrespective of the protein in the feed unless a significant proportion of bypass protein has been provided (p. 17).

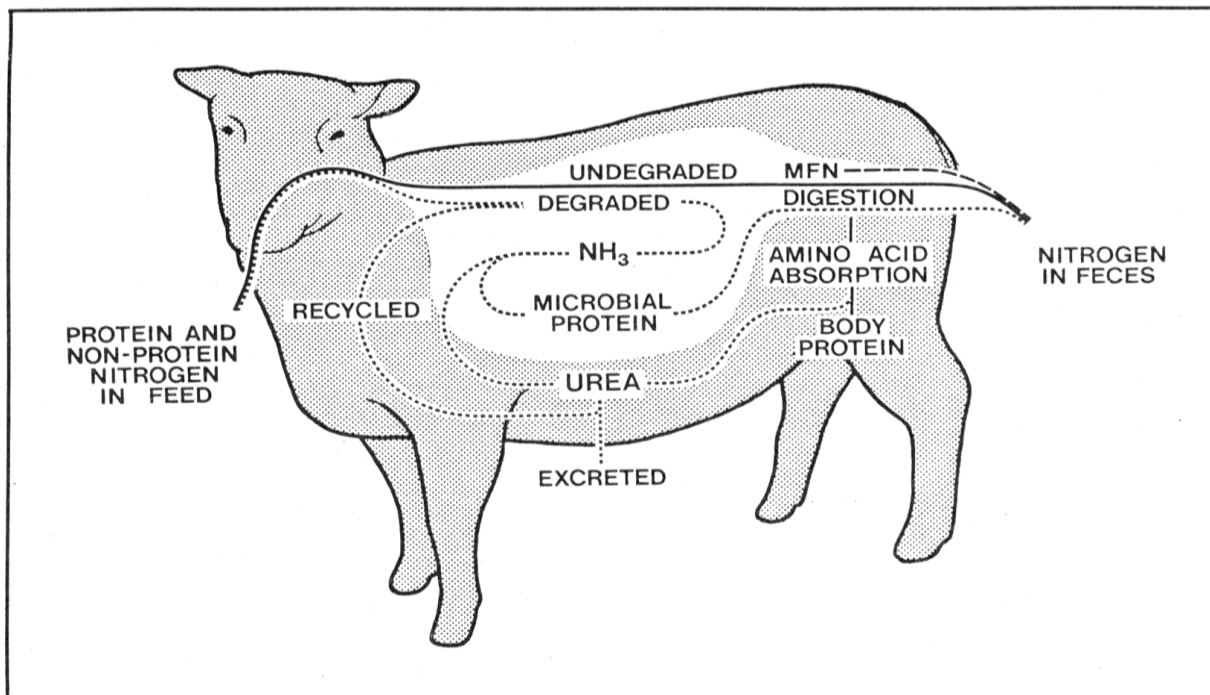

Figure B11 Nitrogen flow in the sheep. MFN is metabolic fecal nitrogen (see page 24).

As described above, protein digestion in the ruminant involves two extra steps compared with that in the monogastric. Each extra step in the digestive process results in some loss of overall efficiency. This, combined with the fact that microbial protein is of mediocre quality, means that sheep are inefficient in utilizing high quality protein in comparison to monogastrics. Since high-quality protein sources are usually expensive, these observations reinforce the concept that sheep rations must be based on inexpensive forages.

Urea in Sheep Rations

As mentioned earlier, urea appears in the rumen in association with saliva. Urea and other non-protein nitrogen (NPN) sources may also be added to sheep rations to increase the level of crude protein. However, to make efficient use of urea it is necessary to appreciate a few features of its metabolism.

Urea and other sources of NPN added to sheep rations are not efficiently utilized until the rumen microbial population becomes adapted to their increased availability. Although this process begins within a few days of the introduction of additional NPN, it may take several weeks before maximum utilization is attained. Therefore, short-term feeding of NPN supplements makes little sense. In addition,

for best results, NPN should be used to contribute *no more than one-third* of the total crude protein content of the complete diet.

The micro-organisms which produce urease (the enzyme responsible for urea breakdown) are concentrated on the lining of the rumen. Consequently, when large quantities of urea are fed over short periods of time, high concentrations of ammonia can accumulate near the rumen walls. This ammonia can produce a rapid increase in rumen pH and after passing into the blood stream can cause alkalosis (high blood pH). The effect is similar, but opposite to the effect produced by grain overload.

In order to be incorporated into microbial protein, the ammonia produced by urea digestion must be combined with organic keto acids to form amino acids (fig. B10). In addition, protein synthesis requires far more energy than is released by urea breakdown. It is important, therefore, when feeding urea to also provide *readily fermentable carbohydrates* as a source of both keto acids and energy. In fact, this principle applies to the efficient utilization of ammonia in the rumen irrespective of its source. Rations should contain approximately 100 grams of TDN for every 12 grams of crude protein *degraded* in the rumen.

When ammonia is produced in excess of the availability of keto acids and energy, it is absorbed through the walls of the rumen into the bloodstream. To some extent it may be recycled into saliva in the form of urea, but the greater proportion will be simply excreted (fig. B11).

The emphasis above was on readily fermentable carbohydrate. It is important that the rate of carbohydrate digestion be well matched to the rate of urea degradation when animals are fed on a periodic basis (i.e. not self-fed). Cellulose, for example, is inappropriate for this purpose because of its slow rate of digestion whereas the starch found in feed grains is ideal (fig. B12). Self feeding, where feed is consumed frequently results in more stable conditions in the rumen and these considerations become somewhat less important.

Bypass Protein

It was suggested earlier that most of the feed protein entering the rumen is degraded to ammonia. In fact, the degree of degradation varies, depending on the source of protein (table B3). For most of the grass forages, protein degradability is in the 80% range; legume forage proteins are closer to 50% degradable. The figure for oats and barley protein is approximately 90%. Among the protein supplements, urea is considered 100% degradable; canola meal in the 90% range and soya meal being significantly lower at about 55%. Fish meal, which is rarely used in sheep rations is the extreme at approximately 35%.

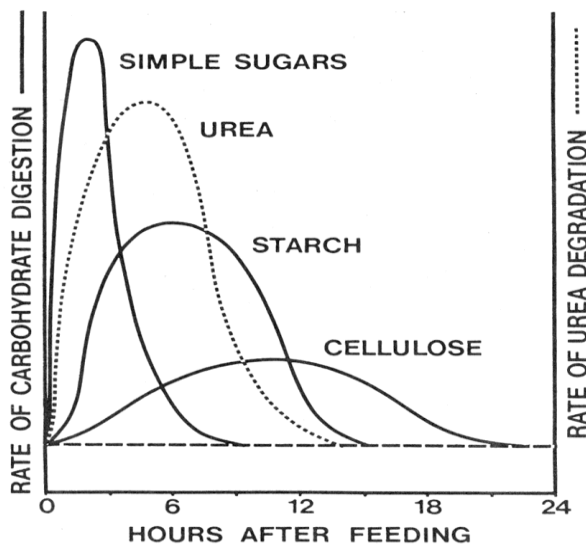

Figure B12 The fermentation rates of various carbohydrates compared with the rate of urea degradation.

Protein which is not degraded in the rumen is termed “bypass protein” or non-degradable dietary protein (UDP). Under some circumstances it is possible to use UDP to improve the overall quality of protein reaching the small intestine. Amino acids released from the UDP upon digestion there may complement the amino acids released from microbial protein resulting in a better *balance* of amino acids being absorbed into the bloodstream. This results in more efficient overall utilization of feed protein.

TABLE B3 The degradability of protein from various sources.

Protein Source	Degradability (%)
Grass Hay.....	70-80
Grass Silage.....	80-90
Legume Hay.....	35-65
Barley Straw.....	75-85
Oats Grain.....	85-95
Barley Grain.....	89-95
Corn Grain.....	60-70
Soyameal.....	45-65
Fishmeal.....	25-45
Canola Meal.....	85-90
Urea.....	100

The concept of UDP explains why some feeds yield better performance results than others even though the total amount of crude protein provided in the ration is the same. For example, milk production is improved when soya meal or fish meal is used in place of urea. Similarly, the superiority of legume forages over grass forages for lactating animals is widely accepted.

Heat Damaged Protein

When silage is poorly packed, excess air can result in significant heating. Similarly, hay which is baled when its moisture content is too high may produce heat. Heating is caused by chemical reactions in the feed which result in part of the protein combining with carbohydrates. The compounds formed are not digestible by rumen microbes. When heat damage is slight, these compounds may be digestible in the abomasum and small intestine serving a role similar to that of bypass protein. However, in most cases, heat damaged protein will be totally indigestible, with the amount of loss being proportional to the degree of heating. A chemical test to determine the degree of loss was discussed in the section on Feed Analysis (p.3).

SECTION C -- NUTRIENT REQUIREMENTS

In North America, nutrient allocations for sheep are based on the recommendations of the U.S. National Research Council (NRC). These are set out in the publication "Nutrient Requirements for Sheep." In the United Kingdom, the recommendations of the Agricultural Research Council (ARC) are used. The recommendations in the present Guide are based on those given by the NRC and in some cases will reflect information found in the ARC publication "The Nutrient Requirements of Ruminant Livestock."

Before discussing specific nutrient requirements, it will be useful to classify the essential nutrients and, at the same time, point out the interrelationships between classes.

ESSENTIAL NUTRIENTS

Water

This is a nutrient which is often overlooked in designing feeding programs for livestock. Its importance is illustrated by the following anecdote.

In 1978, the Alberta Ram Test Station was housed in a closed building on the Calgary Stampede grounds. Although it was well ventilated, it tended to be a little warm. A complete pelleted ration was designed which would promote maximum growth of the lambs on test. Water was provided in automatic, float-operated fountains. The first groups of lambs got off to a rapid start and grew very well for about six weeks (they were weighed every two weeks). After that, growth began to slow and feed consumption decreased, to the dismay of the management, who began looking for causes.

Initially the feed was blamed and a new lot was brought in. Next, the temperature in the barn was considered. Finally, the water was examined. Although the water in the drinking bowl had been kept clean, no attempt had been made to clean the float compartment. Here a healthy population of micro-organisms had developed which was imparting an off-flavor to the water in the drinking bowl. Consequently the lambs were limiting their water intake which was affecting their appetite and thus their growth. As soon as the problem was rectified, rapid gains returned.

The point is this: sheep are fussy drinkers. In addition, if they are forced to subsist on an inadequate water supply in periods when their

nutrient requirements are high, production may suffer. As in the case above, insufficient water intake may result in reduced dry matter consumption and often affects salt and mineral intake. In late pregnant ewes, whose requirements are particularly high, inadequate water intake leading to reduced feed consumption may result in pregnancy toxemia.



Figure C1 Contaminated waterers are a source of disease and may limit feed consumption.

As a demonstration of the benefit of a clean, fresh water supply, feed consumption of feedlot lambs at Fairview College in Alberta was increased by providing water which was constantly circulated past the lambs through rain gutters. The increased intake was apparently the result of appetite stimulation through increased water consumption.

Waterers which are not kept clean (fig. C1) are also a source of disease. Several common health problems which result from fecal contamination are spread through fouled water supplies.

The water consumption of sheep is widely variable, depending on age, stage of production, wool cover, water temperature and environmental temperature and humidity.

TABLE C1 Estimated water intakes for sheep. Values are given as litres of water consumed per kilogram of feed dry matter consumed.

Class of Sheep	Environmental Temperature		
	below 16°C	16-20°C	above 20°C
Lambs (up to 4 weeks).....	4.0	5.0	6.0
Sheep (growing or adult, non-pregnant, dry).....	2.0	2.5	3.0
Pregnant Ewes			
mid pregnancy			
□ single.....	2.5	3.1	3.7
□ twins.....	2.8	3.5	4.2
late pregnancy			
□ single.....	3.3	4.1	4.9
□ twins.....	4.4	5.5	6.6
Lactating Ewes			
first month.....	4.0	5.0	6.0
second month.....	3.0	3.7	4.5
late lactation.....	2.5	3.1	3.7

The consumption of clean snow can account for a significant proportion of water intake in winter, but should not be relied upon as the only source. Sheep consuming feeds which are high in water content (silage, pasture) will satisfy a sizable proportion of their requirements from their feed. Table C1 gives some guidelines to expected water consumption.

Energy

Inadequate energy limits performance more often than any other nutrient deficiency. In lambs the symptoms are most commonly slow growing and lower resistance to infection. Ewes may experience loss of weight, reduced fertility and lamb birth weights, inadequate milk production, shortened lactation periods and reduced wool quantity and quality. Energy deficiency may be a result of insufficient feed intake or, most commonly in B.C., low ration energy (TDN) content.

As suggested earlier, carbohydrates, fats, oils and proteins can all serve as energy sources although the most significant contribution is from the carbohydrates. The total energy content of a feed can be estimated by burning a sample and measuring the amount of heat produced.

Digestible Energy

Of the total energy consumed, some is released by the digestive process or absorbed into the bloodstream while the remainder is contained in indigestible compounds like lignin which are excreted (fig. C2). In the feed analysis procedure, the digestible portion of feed energy is calculated as TDN or DE from measurement of acid detergent fibre (ADF) (see p.4).

Some of the energy which is *apparently digested* is actually lost as gas from the rumen when the animal belches. A second portion is lost through urinary excretion.

Metabolized Energy

Digestible energy minus gaseous and urinary losses is termed metabolizable energy (ME). As mentioned in the section on feed analysis, ME is the basis of energy recommendations in the U.K. For most feeds, the assumption is made that ME amounts to 82% of DE.

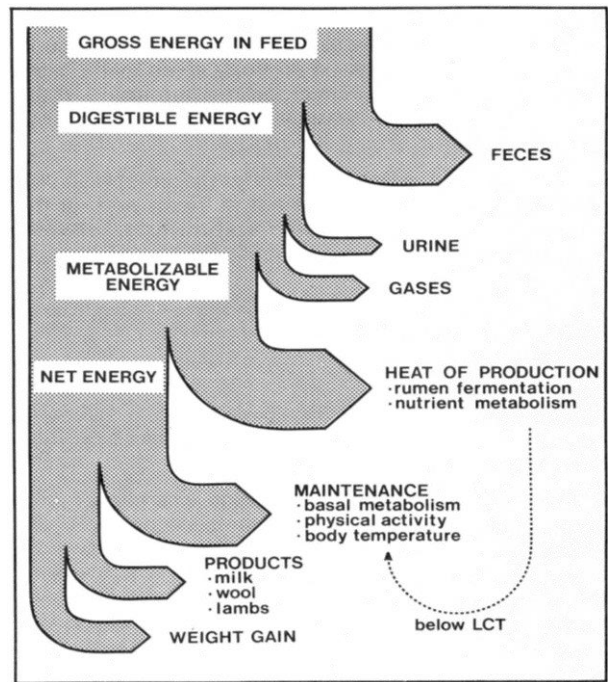

Figure C2 The partition of feed energy consumed by the sheep.

TABLE C2 Examples showing the partitioning of gross energy intake.

Energy Fraction	20 kg lamb gaining 275 grams/day		45 kg lamb gaining 250 grams/day		70 kg ewe during maintenance		70kg ewe 140 days pregnant with twins		70 kg ewe first 8 weeks lactating with twins	
	kcal	%	kcal	%	kcal	%	kcal	%	kcal	%
Gross Energy Intake.....	4397	100	7486	100	5273	100	9259	100	12323	100
Digestible Energy*.....	3210	73	5240	70	2900	55	5370	58	8010	65
Metabolizable Energy.....	2630	60	4300	57	2380	45	4400	48	6570	53
Net Energy for:										
Maintenance.....	1012	23	1380	18	1618	31	1618	17	1618	13
Pregnancy.....							330	4		
Lactation.....									2765	22
Gain.....	1040	24	1400	19						

% Digestible Energy = Ration TDN %

Metabolizable energy is not totally available for production. Some proportion must be utilized for body maintenance, some for physical activity and some for keeping warm, and combating disease and other stresses. What remains for production is termed *Net Energy* and even here, there are costs incurred in the processes by which milk, meat, wool and offspring are produced. These costs are referred to as the *heat of production*.

Finally, energy which is available in excess of that which can be utilized for production is stored, largely in the form of fat. This need not imply that fat is stored only after the animal has reached its maximum potential production. When rations are not *balanced* with respect to the nutrients they contain, fat may be stored even at lower levels of production. For example, muscular growth may be limited by inadequate protein although adequate energy is provided and the excess of energy over protein will be stored as fat. Stored energy may be later mobilized when energy demand exceeds that available in the ration. A few numerical examples of the way in which energy is utilized are given in table C2.

The *energy concentration* in a ration affects both intake and efficiency of utilization. Figure C3 demonstrates that intake decreases as TDN concentration in the ration increases from 55 to 85%. At TDN levels below 55%, intake decreases as the result of increased fibre which reduces the rate of digestion. As far as possible, as energy level falls, the animal consumes more in an attempt to satisfy energy requirements until the absolute limitations of bulk make this impossible. The second effect of ration energy concentration is shown in table C3. The efficiency of ME utilization increases with increasing energy concentration in the ration.

TABLE C3 The effect of ration energy concentration (% TDN) on the efficiency of energy (ME) utilization for various functions.

Function	% efficiency of ME utilization	
	50% TDN	75% TDN
Growth.....	33	48
Ewe maintenance.....	67	73
Fetal development.....	NA	13
Lactation.....	NA	66

Effect of Environment on Energy Requirements

Figure C4 defines a thermoneutral zone for sheep. This is the temperature range in which the heat demand of the environment is offset by the heat released by productive processes (heat of production, fig C2).

The limits of the thermoneutral zone are referred to as the lower and upper critical temperatures. Below the lower critical temperature (LCT) the animal is required to utilize an additional fraction of metabolizable energy (ME) to stay warm through shivering and other heat producing processes.

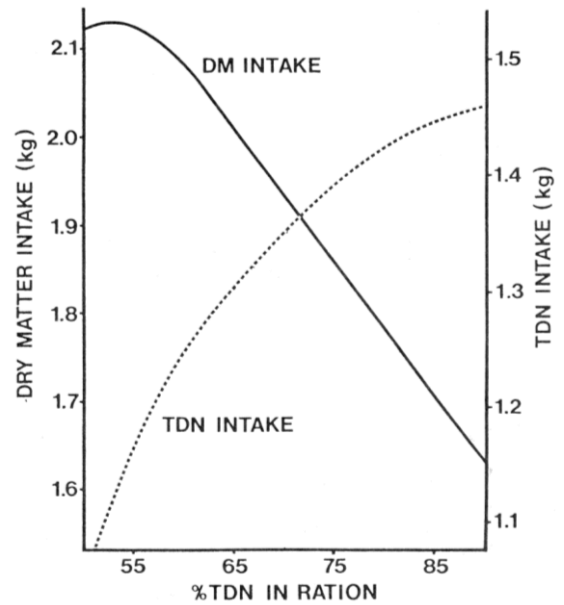

Figure C3 The relationship between ration energy (TDN) content and the intake of dry matter and TDN.

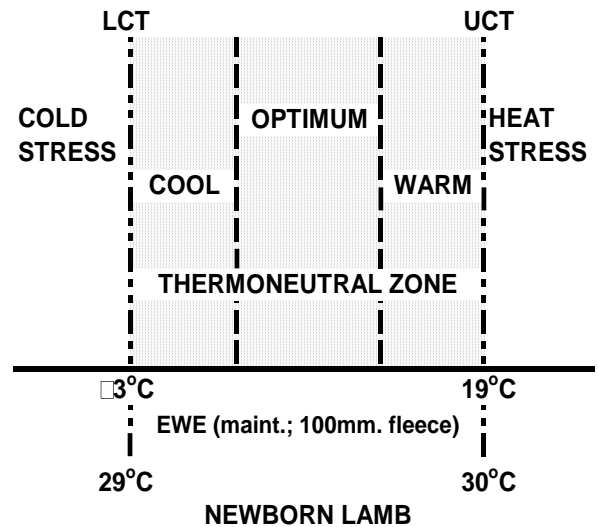

Figure C4 The thermoneutral zone is dependent upon animal size, level of production and amount of insulation. Likewise, above the upper critical temperature (UCT), heat of production becomes a burden to the animal and ME is required to dissipate heat through panting.

The actual values for LCT and UCT are dependent on several factors including the size of the animal, the level of production and the amount of insulation (fat and fleece).

TABLE C4 The effects of wool cover and feeding level on the lower critical temperature for ewes.

Wool Cover, Feeding Level	LCT (°C)
1 mm fleece, maintenance	28
5 mm fleece, fasting	31
5 mm fleece, maintenance	25
5 mm fleece, full feed	18
10 mm fleece, maintenance	22
50 mm fleece, maintenance	9
100 mm fleece, maintenance	-3

Small animals have a large surface area relative to their body size and, therefore, lose heat rapidly. Animals on a high plane of nutrition release more heat of production. Therefore, both their LCT and their UCT are lower. The same is true of animals with a significant covering of fleece. Although upper critical temperatures have seldom been measured experimentally, estimates of LCT under various conditions are given in table C4. For ewes in the maintenance period with varying amounts of wool cover, percent increases in energy cost per degree Celsius below the Lower Critical Temperature are given in table C5.

In addition to its effects on nutrient requirements, the environment can influence both feed intake and nutrient digestibility. In sheep, dry matter intake can be expected to decrease by about 0.5% for every 1°C increase in temperature from -5 to 35°C. Conversely, the digestibility of ration dry matter increases by about .2% for every 1°C rise in temperature in the same range. The net effect of these opposite effects on the performance of growing lambs is shown in table C6.

TABLE C5 Extra insulation reduces the effect of cold temperatures on increasing energy requirements for maintenance.

Fleece Length (mm)	Sheep Weight (kg)				
	40	50	60	70	80
	% Increase in Maintenance Cost per °C below LCT				
10.....	5.8	5.4	5.2	4.7	4.6
40.....	1.9	1.8	1.7	1.6	1.5
70.....	1.2	1.1	1.0	0.9	0.9
100.....	0.8	0.7	0.7	0.7	0.6

It should be appreciated that although this discussion has centred on temperature; wind, humidity and rainfall can all modify the effects of temperature. Wind effectively raises the

thermoneutral zone while humidity lowers the UCT. Rainfall can reduce the insulative value of the fleece, again raising the thermoneutral zone.

TABLE C6 Gain and growth efficiency of lambs raised at different environmental temperatures and fed *ad lib* (without restriction).

Temperature (°C)	Gain (grams/day)	Gain per Unit of feed
-30	73	0.04
-20	130	0.08
-10	170	0.11
0	192	0.15
10	197	0.14
20	184	0.13
30	107	0.08
35	41	0.04

Effect of Physical Activity on Energy Requirements

Table C7 summarizes the available estimates on the energy costs of physical activity. Although the cost of standing over lying and the cost of changing position are relatively small, it has been found that the heat lost by sheep in the standing position in a cold environment can be 70% greater than that when lying. Thus, the total energy savings in an undisturbed flock lying on dry, well bedded grounds in winter may be considerable.

The energy cost of walking may be significant for ewes on extensive pastures. This points out another advantage of intensive grazing management where animals are confined to relatively small areas while satisfying their nutrient requirements.

TABLE C7 The energy requirements for muscular activity. These quantities are in addition to those for maintenance and other productive functions.

Activity	Grams TDN (70 kg ewe)
Walking 1 km on level ground.....	12.1
Walking 1 km while ascending 100 metres...	142.8
Lying down from a standing position and standing up again.....	1.2
Energy cost of standing over lying down (per day).....	45.6

Energy Sources

Energy (TDN) levels of typical B.C. feeds are given in Appendix 1. As suggested earlier, sheep rations should be forage-based with the grains being considered energy supplements.

The exception might be the feeding of lambs to produce high rates of gain. In this case high-grain rations are required to achieve the required energy intake.

Protein

Inadequate ration protein levels result in appetite reduction, lowering intake. In addition, feed which is consumed is less efficiently utilized. The combined effects of reduced intake and inefficient feed utilization extract a heavy toll on production and reproduction including poor growth, muscular development and reduced reproductive efficiency. Extreme protein deficiencies, most commonly the result of parasitism or disease (e.g. Johne's disease), are often seen in the form of anemia and edema (bottle jaw). When ration protein levels approach those found in straw, even the rumen microbial population cannot be maintained, resulting in severe digestive disturbances.

It should be obvious from the discussion on protein digestion that even when adequate energy is provided, microbial protein synthesis cannot progress without a supply of ammonia in the rumen. It was also pointed out that the ammonia and the energy must be present in the same time frame (fig. B12). Thus, energy and protein (ammonia) supply must be balanced in both amount and time.

The total crude protein provided in feed can be partitioned in much the same way as energy was partitioned above. This is illustrated in figure C5.

Digestible Protein

Crude protein (CP) is an estimate of the total protein available to the ruminant (p.4). Some proportion of CP is completely unavailable to the animal (eg., heat damaged protein) and is excreted in the feces. However, fecal protein also contains contributions from microbial protein which has escaped digestion, from spent digestive enzymes and from tissue which was been sloughed and abraded from the lining of the digestive tract. These contributions are collectively termed *metabolic fecal protein*. The difference between crude protein and fecal protein is referred to as *apparent digestible protein*:

$$\begin{aligned} \text{Apparent Digestible Protein} \\ = \text{Crude Protein} - \text{Fecal Protein} \end{aligned}$$

and

$$\begin{aligned} \text{Apparent Protein Digestibility} \\ = \frac{\text{Apparent Digestible Protein}}{\text{Crude Protein}} \end{aligned}$$

True digestible protein is a measure of the difference between the crude protein consumed in the ration and that portion of *fecal protein* which was derived directly from the ration. The latter is very difficult to measure and, therefore, *true digestible protein* is seldom used in ration formulation. The digestible protein requirements given in Appendix II" refer to *apparent digestible protein*. In fact, the *apparent* and *true* digestibility of the protein in concentrate rations (grain, protein supplements) is in close agreement.

However, roughages having higher fibre and lower crude protein levels demonstrate decreasing apparent protein digestibility. This is the result of an increased contribution of metabolic fecal protein to total fecal protein excretion. In other words, *apparent protein digestibility* is a rather poor estimate of *true protein digestibility* for many roughages. The NRC digestible protein recommendations are, however, derived for roughage-based rations.

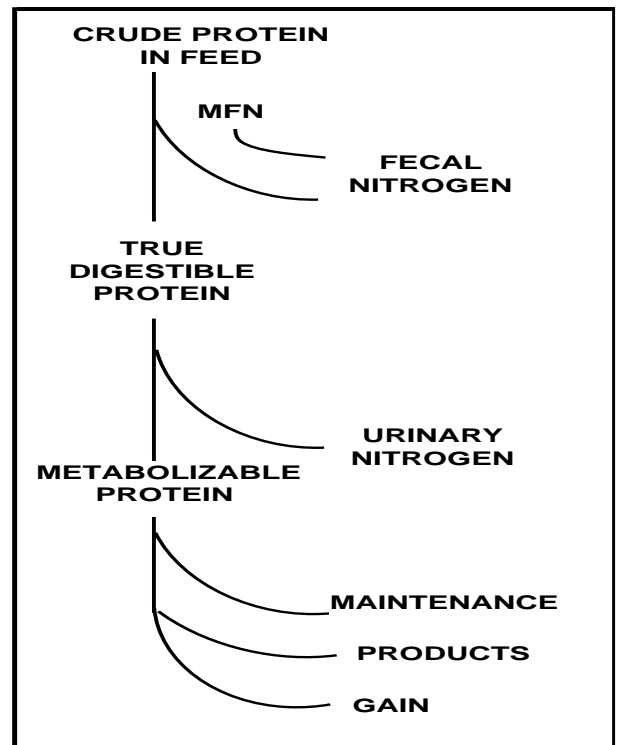

Figure C5 The partition of crude protein consumed by the sheep.

Metabolizable Protein

Protein which is eventually digested and absorbed as amino acids in the small intestine can be used to meet the protein requirements of the animal body.

The efficiency of this process depends to some extent, on protein quality which, as discussed earlier (p. 14), is dependent upon the balance of amino acids absorbed. The contribution of bypass protein to this balance has also been mentioned. These concepts are illustrated in figure B11.

Determination of bypass protein requirement has been the topic of a great deal of research. However, it is not yet possible to make firm recommendations on the basis of the information available.

A second factor which determines the efficiency with which amino acids are used to manufacture new protein is the level of energy nutrition. When the energy demand of an animal is not fully met by non-protein sources, then the energy deficit may be met by using amino acids. This effectively reduces the amount of amino acids available for protein synthesis. This again points out the critical importance of nutrient *balance* when formulating rations. Amino groups released from amino acids used as energy sources are subject to either urinary excretion or recycling through saliva in the form of urea (fig B11).

As far as possible, protein requirements should be met through forage due to the high cost of supplementation. Where supplements are required, the most common form is the 32-50% crude protein pellet. A wide variety of formulations are available, many containing urea. Subject to the considerations on urea feeding discussed earlier, most can be used for sheep. When protein supplements contain urea, this will be noted on the label as "ECP from NPS", meaning equivalent crude protein from non-protein sources. Fig C6 shows the analysis of a 32% urea-free protein pellet suitable for all classes of sheep.

Minerals

Fifteen minerals have been demonstrated as essential in sheep nutrition. Of these, seven are termed *macromineral nutrients* implying that they are required in relatively large quantities. These are:

- sodium
- chlorine
- calcium
- phosphorus
- magnesium
- potassium
- sulphur

The remaining eight essential minerals are referred to as trace or *micromineral nutrients*:

- iodine
- cobalt
- iron
- manganese
- zinc
- selenium
- copper
- molybdenum

Although these are required in relatively small quantities, it should not be inferred that they are any less important.

Table C8 describes the functions and symptoms of deficiency of the essential minerals. Notice in the column entitled "special considerations" that reference is made to interactions between minerals and between specific minerals and vitamins. Some of these demand particular attention because they are often involved in practical feeding problems.

Mineral Interaction

Calcium and Phosphorus

These two minerals require adequate magnesium and vitamin D for proper utilization. In addition, the ratio of calcium to phosphorus in rations should be

32% SHEEP SUPPLEMENT

REG. No. 22365

INGREDIENTS

The ingredients in this feed are those named in the Certificate of Registration. This feed contains added selenium at 1.0 mg/kg.

GUARANTEED ANALYSIS

Protein * (Min.)	32.0%
Fat (Min.).....	4.0%
Fibre (Max.).....	9.0%
Salt (Actual).....	4.0%
Calcium (Actual).....	2.3%
Phosphorus (Actual).....	1.0%
Iron (Actual).....	.04%
Iodine (Actual).....	.0008%
Fluorine (Max.).....	.02%
Vitamin A (Min.).....	45,000 I.U./kg.
Vitamin E (Min.).....	200 I.U./kg.

* This includes not more than 20.0% equivalent crude protein from Urea.

Figure C6 The analysis of a typical 32% protein pellet suitable for lambs.

Protein Sources

in the 1:1 to 5:1 range. Higher proportions of calcium can reduce phosphorus absorption and, conversely, high phosphorus levels can reduce calcium availability. This is yet another situation where *balance* is important.

Copper, Molybdenum and Sulphur

Many B.C. feeds are deficient in copper. Furthermore, feeds which contain adequate copper levels in company with high molybdenum levels are effectively copper deficient. Molybdenum reduces copper availability and high sulphur levels amplify this effect. Ration copper levels should be 5 times those for molybdenum when sulphur levels are not abnormally high.

Selenium and Vitamin E

Both selenium and vitamin E are involved in the maintenance of tissue membranes. As a result they have a “sparing” effect on one another. Levels of selenium which are more than adequate can reduce the requirements for vitamin E and vice versa. There is no good evidence to suggest that either nutrient influences the absorption of the other.

Cobalt and vitamin B₁₂

Cobalt is an essential component of Vitamin B₁₂. When cobalt intake is inadequate, B₁₂ synthesis by the rumen microbes is reduced and symptoms of vitamin deficiency.

Mineral Sources

Since most of the feeds grown in B.C. are mineral deficient, the need for supplementation is virtually inevitable. Many mineral mixes are available and it is essential that an appropriate formulation is chosen to satisfy both the type and degree of deficiency being treated.

Salt

Salt simply consists of sodium and chloride and provides no other minerals in significant amounts. It is available loose and in blocks (licks) and is distinguishable by the white colour.

Iodized Salt

Iodine deficiency is universal and, in fact, white salt for human consumption is iodized by law. Iodized salt for animals is dyed a rust colour and again is available loose or in licks.

Cobalt-Iodized Salt

This is the common blue salt used for ruminant animals. The loose form should be used as a supplement for sheep when the ration contains adequate levels of the other essential nutrients. It is preferable to either plain salt or iodized salt because of prevalent cobalt deficiencies in our feeds.

TABLE C8 Essential minerals; their functions, deficiency and toxicity symptoms and special considerations relating to flock management.

Mineral	Primary Functions	Deficiency Symptoms	Special Considerations
Sodium (Na) and Chlorine (Cl) Salt (NaCl)	<input type="checkbox"/> body fluid balance <input type="checkbox"/> appetite stimulant	<input type="checkbox"/> chewing wood, licking dirt, eating toxic amounts of poisonous plants <input type="checkbox"/> decreased appetite <input type="checkbox"/> decreased feed efficiency	<input type="checkbox"/> when mixed with rations or minerals mixes, may be used to limit their consumption
Calcium (Ca)	<input type="checkbox"/> bone formation <input type="checkbox"/> muscle contraction	<input type="checkbox"/> abnormal development of bone and in severe cases rickets and tetany	<input type="checkbox"/> deficiency symptoms develop slowly as calcium is drawn from the bones <input type="checkbox"/> vitamin D required for proper utilization of both Ca and P <input type="checkbox"/> Ca:P ration should be in 1:1 to 5:1 range <input type="checkbox"/> mature forages are often low in Phosphorus <input type="checkbox"/> deficiency common in British Columbia
Phosphorus (P)	<input type="checkbox"/> enzyme activity <input type="checkbox"/> energy metabolism	<input type="checkbox"/> slow growth <input type="checkbox"/> depraved appetite such as wool picking <input type="checkbox"/> unthrifty appearance <input type="checkbox"/> listlessness <input type="checkbox"/> poor reproductive performance affecting conception and lambing rate	<input type="checkbox"/> function and metabolism of Mg closely tied to that of Ca and P
Magnesium (Mg)	<input type="checkbox"/> enzyme activity <input type="checkbox"/> nerve activity	<input type="checkbox"/> tetany (most often on fast growing pasture in the form of grass tetany) <input type="checkbox"/> irritability	<input type="checkbox"/> K supplementation (as potassium chloride) may help to reduce the incidence of urinary calculi in rams <input type="checkbox"/> deficiency most common when high concentrate rations are fed
Potassium (K)	<input type="checkbox"/> appetite stimulant <input type="checkbox"/> enzyme, muscle and nerve function <input type="checkbox"/> rumen microbial activity	<input type="checkbox"/> poor appetite and feed efficiency <input type="checkbox"/> dry wool <input type="checkbox"/> stiffness progressing from front to rear <input type="checkbox"/> urinary calculi	<input type="checkbox"/> dietary nitrogen(CP/6.25): sulfur ratio should be in 10:1 range <input type="checkbox"/> diets high in urea may be low in sulfur
Sulphur (S)	<input type="checkbox"/> synthesis of some essential amino acids particularly prevalent in wool	<input type="checkbox"/> similar to protein deficiency <input type="checkbox"/> excess salivation, runny eyes and wool shedding	<input type="checkbox"/> enlargement of the thyroid gland (goiter) <input type="checkbox"/> lambs born dead, weak or without wool <input type="checkbox"/> reduced wool yield and conception rate
Iodine (I)	<input type="checkbox"/> formation of the hormone thyroxin in the thyroid gland	<input type="checkbox"/> poor appetite <input type="checkbox"/> unthrifty appearance <input type="checkbox"/> emaciation, weakness and anemia <input type="checkbox"/> decreased productivity and fertility	<input type="checkbox"/> salt, except when used to limit ration intake, should always be iodized <input type="checkbox"/> deficiency common when non-iodized salt is fed
Cobalt (Co)	<input type="checkbox"/> cofactor in vitamin B ₁₂ synthesis by rumen microbes	<input type="checkbox"/> should always be present in free-choice salt mix	

TABLE C8 Essential minerals; their functions, deficiency and toxicity symptoms and special considerations relating to flock management. – Continued

Mineral	Primary Functions	Deficiency Symptoms	Special Consideration
Iron (Fe)	<ul style="list-style-type: none"> □hemoglobin formation 	<ul style="list-style-type: none"> □anemia 	<ul style="list-style-type: none"> □anemia may be associated with feeding lambs on slotted floors or with heavy intestinal parasite loads
Copper (Cu)	<ul style="list-style-type: none"> □related to absorption of iron □wool formation 	<ul style="list-style-type: none"> □muscular incoordination in nursing lambs (swayback) □steely or stringy wool lacking in crimp and tensile strength □loss of wool colour in black sheep □TOXICITY produces sudden death 	<ul style="list-style-type: none"> □copper requirement depends on molybdenum level in diet-- Cu:Mo ratio should be 5:1 □Cu consumed at high levels over long periods accumulates in the liver-- stress results in rapid release, jaundice and death □deficiency common in B.C.
Molybdenum (Mo)	<ul style="list-style-type: none"> □aids digestive process but interferes with Cu absorption 	<ul style="list-style-type: none"> □high levels (1 + ppm) may provoke copper deficiency 	<ul style="list-style-type: none"> □Cu:Mo ratio should be in 5:1 range
Manganese (Mn)	<ul style="list-style-type: none"> □development of bone 	<ul style="list-style-type: none"> □in goats, deficiency is related to delayed onset of estrus, poor conception rate, low birth weight of kids 	<ul style="list-style-type: none"> □exact requirements and deficiency symptoms for sheep are not known with any certainty
Zinc (Zn)	<ul style="list-style-type: none"> □male reproduction □growth processes through role in protein utilization 	<ul style="list-style-type: none"> □impaired growth of testes in ram lambs □cessation of sperm production □wool loss, swelling and lesions around hooves and eyes, excess salivation, loss of appetite, wool picking, listlessness, reduced growth 	<ul style="list-style-type: none"> □deficiency common in B.C. □healthy hooves require Zn
Selenium (Se)	<ul style="list-style-type: none"> □enzyme activity □vitamin E metabolism 	<ul style="list-style-type: none"> □reduced growth □white muscle disease □impaired fertility □lambing problems 	<ul style="list-style-type: none"> □Se deficiency is common in B.C. and in cattle it has been linked with high levels of calf loss
Fluorine	<ul style="list-style-type: none"> □not known 	<ul style="list-style-type: none"> □TOXICITY produces loss of appetite and degenerative changes in bones and teeth 	<ul style="list-style-type: none"> □excess F intake may be due to water supply or use of non-defluorinated rock phosphate

TRACE MINERALIZED SALT

for

EWES, BEEF COWS AND REPLACEMENT BEEF HEIFERS

REG. No. 22440

INGREDIENTS

Salt (NaCl), Zinc Oxide, Ferrous Carbonate, Manganous Oxide, Copper Oxide, Calcium Iodate, Cobalt Carbonate, Iron Oxide, Mineral Oil (dust control agent), Sodium Selenate or Sodium Selenite.

This feed contains Selenium at 25 gm/tonne.

GUARANTEED ANALYSIS

Salt	(actual)	96.50%
Zinc	(actual)	0.04%
Iron.....	(actual)	0.16%
Manganese	(actual)	0.12%
Copper	(actual)	0.033%
Iodine.....	(actual)	0.010%
Cobalt.....	(actual)	0.004%

Figure C7 Typical analysis of a trace mineralized salt with selenium.

TM Salt

Trace mineralized salt formulations are generally 95-97% salt with several of the essential micromineral nutrients added. Figure C7 shows a typical analysis containing selenium at 25 grams/tonne. This is the highest level permitted without a veterinary prescription. Minor deficiencies can be overcome by feeding these in loose form (in a covered feeder) free-choice. For sheep, the copper level in these supplements should be in the 0.01-0.05% range.

Mineral Mixes

Livestock mineral mixes are almost infinite in variety. They commonly contain 18-20% Calcium and Phosphorus, (1:1 mineral), no salt and all of the essential trace minerals except molybdenum and selenium. Others contain up to 30% salt and several include selenium at 25 mg/tonne (or higher on prescription). For most conditions under which sheep are raised in B.C., the following guidelines should be followed:

- 15-20% Calcium
- 15-20% Phosphorus

up to 30% salt
0.01-0.05% copper

A typical analysis which meets these criteria is shown in figure C8.

When sheep are being fed large amounts of alfalfa, a mineral mix containing high phosphorus with little calcium might be required. Conversely, lambs receiving high concentrate rations will require the higher proportion of calcium found in a 2:1 mineral mix (typically 18-20% calcium: 9-10% phosphorus).

Sheep producers should be particularly concerned about the copper content of the mineral supplements they use. Many of those available in B.C. (formulated for cattle) have copper levels in excess of 0.2%. The use of these products have resulted in several cases of copper poisoning.

Mineral feeding practices will be further discussed under Feeding Management (p.50).

Limestone

Limestone is simply a calcium supplement which is used to complement high grain rations which are calcium deficient. Its main application is in supplementing concentrate rations for growing lambs.

Injectable Vitamin E – Selenium

Selenium in combination with vitamin E is available in preparations designed to prevent the occurrence of white muscle disease in lambs. These are administered to the ewe a few weeks before lambing and, as extra insurance to the newborn lamb.

Vitamins

The tissues of ruminant animals require the same range of vitamins required by other mammals. However, rumen microbes synthesize the full range of B-vitamins in amounts adequate to satisfy requirements. These B vitamins are listed in table C9.

As mentioned earlier, cobalt is required for the synthesis of vitamin B₁₂ and the symptoms of inadequate cobalt intake are simply those of B₁₂ deficiency. Thiamine (vitamin B₁) deficiency is not uncommon in growing lambs where it is recognized as polioencephalomalacia. However, the deficiency is apparently not the result of inadequate thiamine production but, rather, of the destruction of the vitamin by a rumen enzyme of microbial origin. The conditions

which promote the production of this enzyme are poorly understood.

TABLE C9 The water-soluble B-complex vitamins. Sheep ration need not contain any of these since they are all synthesized by bacteria in the rumen.

vitamin B ₁₂	pantothenic acid
biotin	para amino benzoic acid
choline	pyridozine (B ₆)
folic acid	riboflavin (B ₂)
inositol	thiamin (B ₁)
niacin	

SHEEP MINERAL

Reg. No. 740002

INGREDIENTS

Tricalcium phosphate, Dicalcium phosphate, Monoammonium Phosphate, Limestone, Iron Oxide, Ethylenediamine Dihydrochloride, salt, zinc oxide, Manganous Oxide, Cobalt Sulfate, Cupric Oxide, Vitamin A Acetate, Animal Sterol irradiated (Source Vitamin D3), Mineral Oil, Molasses, Diatomaceous Earth, Anise.

GUARANTEED ANALYSIS

Calcium (actual)	19.0%
Phosphorus (actual).....	17.0%
Fluorine (max).....	2,000 mg./kg.
Iron (actual)	10,000 mg./kg.
Iodine (actual).....	100 mg./kg.
Zinc (actual).....	10,000 mg./kg.
Manganese (actual).....	5,000 mg./kg.
Cobalt (actual).....	50 mg./kg.
Copper (actual).....	50 mg./kg.
Vitamin A (min.)	500,000 I.U./kg.
Vitamin D (min.).....	50,000 I.U./kg.

DIRECTIONS FOR USE

Feed free choice or allow 10-15 gms. per head per day. For convenience this mineral may be mixed half and half with salt or trace mineralized salt.

Note: Sheep are susceptible to copper deficiency and copper toxicosis. Consult a qualified nutritionist or veterinarian to determine the suitability of this feed to local conditions.

Figure C8 A mineral mix suitable for most B.C. sheep flocks.

Vitamin A

Vitamin A is essential in the maintenance of epithelial (surface) tissues such as those lining the digestive, respiratory, urinary and reproductive tracts as well as that covering the eyes. Deficiency results in night blindness, a decreased resistance to infection, wool loss and the birth of malformed, weak or dead lambs.

Sheep normally derive their vitamin A requirements from carotene which is a yellow pigment found in forages in association with chlorophyll. Forages which have been badly weathered for long periods before storage are low in carotene. Likewise, winter range is a poor source of carotene. In general, green forages contain levels providing for adequate vitamin A synthesis.

Vitamin A is stored in the liver where it is synthesized in excess of requirements. In fact, enough may be stored to maintain production for up to 4 months when animals are fed low carotene rations.

Vitamin D

Classically, vitamin D was identified as the factor responsible for the prevention of rickets. This is due to its essential role in calcium absorption, deposition in and mobilization from bone. Vitamin D deficiency is not a common problem. Like vitamin A, it is derived from green forages, but, in addition, it is synthesized in the skin on irradiation by sunlight. Vitamin D stored in the liver can be drawn upon when intake and synthesis are inadequate.

Vitamin E

Nursing lambs up to 8 weeks of age require vitamin E but, otherwise, it seems to be of little importance in sheep nutrition. Deficiency of vitamin E is seen as white muscle disease. As suggested earlier, vitamin E and selenium have mutual "sparing" effects. That is, the vitamin E requirement is decreased when adequate selenium is available.

Vitamin E is widely distributed in feeds, although it is subjected to loss by oxidation. Therefore, feeds which have been weathered, heated or stored for prolonged periods (over a year) are poor sources while pasture is ideal.

Vitamin K

This vitamin is normally synthesized in large amounts by rumen microbes. In addition, green leafy materials either stored or fresh, are good sources. However,

apparent vitamin K deficiency may occur when mouldy hay is fed. In particular, sweet clover hay contains coumarin, the substance responsible for its sweet smell. Moulds convert coumarin to dicoumarol which effectively reduces the activity of vitamin K in the blood clotting process, resulting in hemorrhage and death.

Vitamin Sources

Under normal feeding conditions, the only vitamins required in the diet are A, D and E. As suggested in the previous discussion, all are provided in green, leafy forages. When these are unavailable, the vitamins may be supplemented by intramuscular injection. Since they are stored in the liver, there is no need to supplement more often than every three months, with the first supplement being given three months after suitable feeds become unavailable.

Mineral mixes often contain vitamins A, D and E. However, they should not be considered reliable sources since all three vitamins are subjected to oxidation. When mineral mixes become moist, a common occurrence in B.C., destruction of the vitamins is rapid.

Vitamins A, D and E with selenium are available from some veterinarians on prescription as a powdered pre-mix. This is either added to the feed or mixed fresh with mineral as it is put out.

Since vitamin E is apparently only required by the young lamb, supplements in the form of vitamin E-selenium preparations may be administered to the ewe before lambing or to the lamb at birth.

Balanced Rations

Nutrient balance has been frequently mentioned in the previous discussion. The importance of balance is clearly illustrated by the most *limiting nutrient concept* which states that production is restricted to the level which can be supported by the most limiting nutrient. This is shown diagrammatically in figure C9. The net result of *imbalanced* rations is the inefficient use of feed resources.

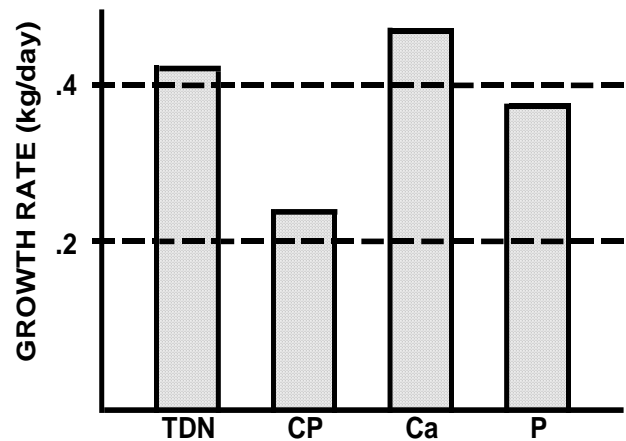

Figure C9 Production is restricted to the level which can be supported by the most limiting nutrient. Here crude protein is most limiting.

Priority for Nutrients

Nutrients which are absorbed from the digestive tract are allocated to satisfy the animal's requirements. Some requirements have priority over others. For example, the nutrients available to a growing lamb must satisfy a requirement for body maintenance and a requirement for gain in weight. It should be obvious that the maintenance requirement has priority over the requirement for gain since a lamb cannot grow until it first replaces tissue lost to the process of turnover.

This concept has fundamental importance to the management of lamb feeding. Figure C10 demonstrates the point for a 30kg lamb receiving various amounts of a ration balanced to support maximum growth. Maintenance requires 1.3 kg of ration and with this amount, no growth occurs. A further 0.4kg supports maintenance in addition to a daily gain of 0.25kg while 2.1kg of ration results in a daily gain of 0.5kg.

The concept of nutrient priority also applies to the ewe during gestation and lactation. In these situations, maintenance has a lower priority than production of either fetus or milk. Figure C11 illustrates the point for the late pregnant ewe.

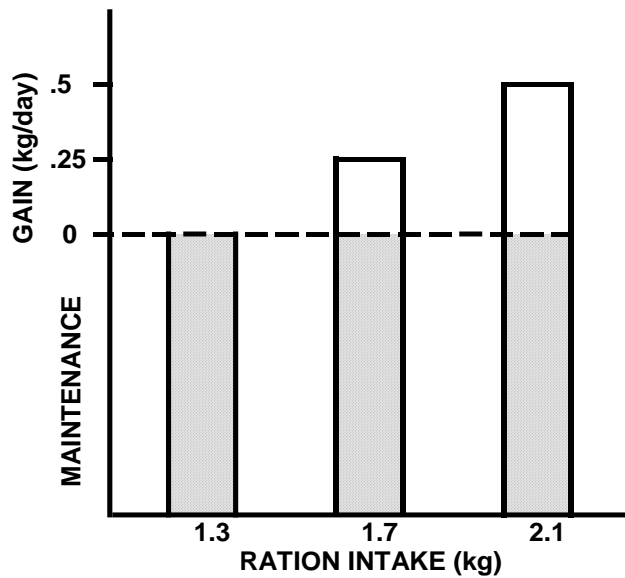

Figure C10 Nutrients consumed by the growing lamb are first allocated to maintenance. Additional nutrients are available for gain.

The restriction of energy intake down to 80% of the recommended level has little effect on fetal size at birth while significantly reducing the ewe's gain in weight before lambing. Likewise, animals which have the genetic capacity to lactate heavily will produce milk at the expense of body tissue.

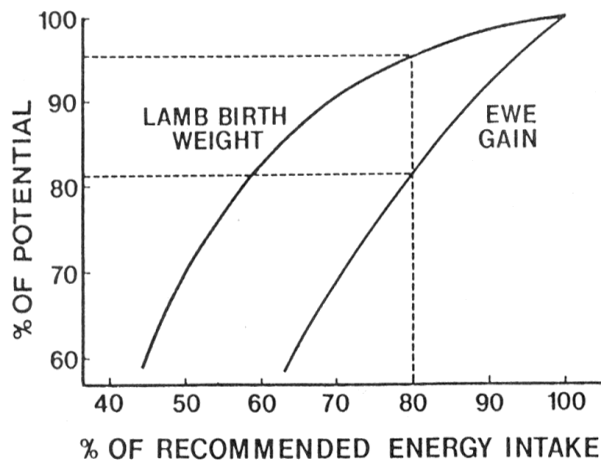

Figure C11 The pregnant ewe may sacrifice the maintenance of her own body to the production of a viable lamb.

NUTRIENT REQUIREMENTS OF EWES

Tables of nutrient requirements for ewes are given in Appendix II. These are based on those given in the NRC publication in Appendix II.

Slavish adherence to these recommendations is no guarantee of success in achieving the primary goal of the commercial sheep enterprise which is the production of market lambs at minimum cost. In some cases, departure from the recommendations will result in a production penalty which is more than compensated by a decrease in feed costs. In other cases, genetically superior animals will yield significantly improved returns when nutrient allocations are increased beyond the recommendations. Only a firm understanding of the implications of feeding management combined with clearcut objectives and assessment of responses will lead to success.

Liveweight and Condition Score Targets

Objectives for the feeding of ewes can be stated in terms of liveweight and condition score targets at various stages of the reproductive cycle. These are suggested for ewes giving birth to twins in figure C12. The left hand axis gives relative liveweight as a percentage of liveweight when condition score is 3.5 (the practice of condition scoring is described in Section E). Condition scores are given along the top. One condition score should be roughly equivalent to 10kg (22lbs) or 15% of mature liveweight.

Why use both liveweight and condition score targets? Clearly the ewe's weight change during pregnancy may be quite independent of her condition. In fact, the targets given in figure C12 suggest that a 13kg (29lb) weight gain should be accompanied by a 5 kg (11lb) drop in condition (score decrease of 0.5). The 18kg (40lb) discrepancy is accounted for by growth of wool, the products of conception (fig.C13) and the development of the udder.

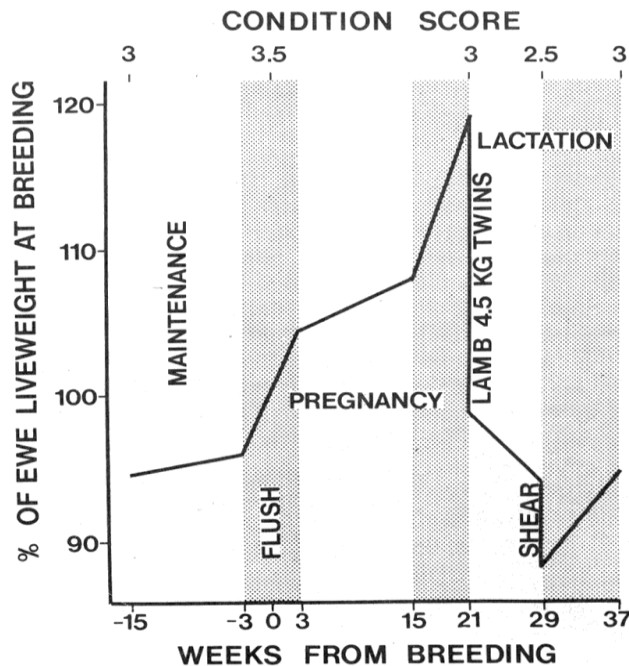

Figure C12 Liveweight and condition score targets for mature ewes.

Feed Intake

Feed consumption by the ewe is controlled by several factors. The most obvious is the amount of feed actually offered. When hay, silage or grain are fed and there is enough bunk space for all animals to eat at once, then intake can be *restricted* by the flock manager. This usually results in more efficient use of feed resources than is the case when ewes are fed *ad lib*. The latter refers to the practice of allowing animals to consume feed to satisfy their appetites and often results in wasted feed as shown in figure E4 (p.49). Even when ewes are fed *ad lib*, however, the amount of feed consumed will vary between 3 and 3.5% of body weight depending upon the quality of the feed and the physiological state of the ewe.

In terms of feed quality, two factors affect feed intake:

- (1) The energy concentration of the ration. When rations of reasonable quality are offered, animals will eat to satisfy their energy requirements. Therefore, as the TDN content of the feed increases, intake will decrease so that a marginally increased amount of total energy will be consumed (fig. C3).
- (2) The fibre content of the ration. When poor quality roughages are fed (TDN less than 55%) intake is limited because of the time it takes to digest the fibre. On very poor quality rations there are often insufficient nutrients to even

maintain a healthy microbial population, further slowing fibre breakdown.

Feed intake will vary during different periods of the reproductive cycle even when the same feeds are fed throughout. For example:

- (1) Intake may decline in late pregnancy. In most situations this is a result of physical restriction of rumen size. Overfat ewes bearing large multiple fetuses are particularly constrained in the amount of feed they can consume. It is, therefore, important not to allow ewes to become overfat (condition score 3.5+) in mid pregnancy. If intake does decline markedly in late pregnancy, the quality of the ration should be increased to meet the nutrient (particularly energy) requirements of the ewe. When an excess of fat is called upon to contribute substantially to energy requirements, pregnancy toxemia may result.
- (2) Feed consumption may increase sharply within a few days after lambing. Maximum *ad lib* intakes usually occur at about six weeks, shortly after peak milk production has been reached. Ewes nursing multiple lambs often consume 10-20% more feed than ewes with singles.

Projected feed intakes for ewes are given in Appendix II.

Other factors which affect voluntary feed intake include ration palatability and water quality and availability. Several experiments have demonstrated that water deprivation and even unpalatable water can depress feed consumption.

Under pasture conditions it is very difficult to determine feed consumption, especially when ewes are grazed extensively. Under intensive grazing management it is possible to control intake to some extent by regulating the amount of pasture being offered and the height to which it is grazed before rotating. When grazing animals are allowed to become selective, intake will be affected by the forage species available and their maturity. Most forage species become less palatable as they approach the reproductive stage.

Maintenance

The maintenance period extends from weaning until the beginning of flushing. During this time it is possible to compensate for failure to realize targets during pregnancy and lactation. The feeding level here will therefore depend upon the ewes' condition scores at weaning. Those that are overconditioned

may be allowed to lose some weight, yielding an opportunity to utilize inventories of lower quality feeds. Ewes in lean to medium condition should not be allowed to lose weight. It is an absolute fallacy to believe that ewes should be starved during this period in order to achieve a good flushing response.

The goal for nutrition during the maintenance period is to produce a healthy ewe with a solid 3 condition score three weeks before breeding begins. This should apply to each individual ewe rather than the flock average. Midway through the maintenance period ewes should be scored and the leanest ewes separated for preferential treatment. These are often the most productive ewes which, because they have nursed multiple lambs deserve special attention. It may be possible at this time, for example, to use high scoring ewes to clean up rank pasture while using pastures in better condition for the lean ewes. Since pasture conditions often decline as the season progresses, it is usually much easier to add weight to the ewes early in the season with an eye to simply maintaining it later.

At the end of the maintenance period, ewes should again be scored. Since this often coincides with the end of the pasture season, it is also an opportune time to deworm and hoof trim the flock. Individuals that stand out as unresponsive to improved nutrition should be considered for culling. They may be subjected to one of several health problems which will severely limit future productivity. These would include chronic pneumonia, Johne's disease and caseous lymphadenitis. At this same time ewes should be examined for lumpy udders, broken mouths, abscesses (caseous lymphadenitis) and external parasites. Any one of these may limit an animal's response to even the best nutritional management.

Flushing

Feeding management during the flushing period has been the subject of considerable controversy in the past because of a lack of clear experimental evidence. It can be confidently stated, however, that the goal of flushing is to achieve a condition score of 3.5 at breeding. Beyond this point, ovulation rate cannot be expected to increase significantly. Furthermore, the level of current nutrition apparently has little effect when this condition score has been achieved. That is, ovulation rate at this point is little affected whether the ewe is gaining or simply maintaining weight. Weight loss will, however, have a negative effect. Current feeding level has more relevance for ewes with condition scores in the 2 to 3 range. In these cases, weight gain has a positive effect on ovulation

rate. Conversely, in these ewes weight loss may produce the opposite effect. Where condition scores at breeding are below 2, little can be done to improve ovulation rate.

The effect of condition score at breeding on ovulation rate differs between breeds. For example, prolific breeds like the Finnish Landrace are significantly less responsive than either Suffolks or Dorsets.

Although research results are inconclusive, flushing probably has less effect on ovulation rate when ewes are bred during the peak of the breeding season (October- November) than it does at either end.

Adequate condition at breeding time is important for reasons other than ensuring high ovulation rates. As seen in figure C12, a sizable increase in weight during pregnancy may be accompanied by a reduction in body reserves (decrease in condition). Likewise, heavy lactation is accompanied by depletion of reserves. Many management systems are based on the utilization of low-cost feeds of mediocre quality during early pregnancy. In order to maintain high level of reproductive performance, it is important that the ewe begins the process in good condition.

Before proceeding with the discussion of nutrient requirements during pregnancy and lactation, it should be appreciated that we are ultimately concerned with the management of the entire *flock* of ewes. Although it is important to recognize the requirements of individuals within that flock, in practice feeding is done on a group basis to satisfy the average needs of that group. Of course, the smaller the groups become, the less variation there should be in the requirements of individuals within the group, and the more accurately can their requirements be met.

When ewes are in good condition at mating and rams are fertile, breeding should be 90% complete within 3 weeks. Even under these conditions, nutritional management must be a compromise between the requirements of the early and late breeders. In most large flocks (except where estrus synchronization is practiced) no attempt is made to identify and group ewes on the basis of breeding date although this practice can result in significant feed savings. Therefore, it should be realized that the following discussion on nutrient requirements is focused on individual needs and that these must ultimately be put in the context of practical flock management. This will be attempted in the section on Feed Testing and Ration Formulation and Feed Management.

Early Pregnancy (First Month)

Depending upon breed and nutritional management, up to five eggs (ova) may be shed into the uterus at ovulation. Mating with a fertile ram should result in the fertilization of all of these, although on a flock basis a 5-10% rate of non-fertilization may occur. After conception has taken place the fertilized egg (later the embryo) floats freely in the fluids of the uterus for about two weeks. During the third week the embryo begins to attach to the lining of the uterus, a process which takes a further two to three weeks.

Nutritional management in the first month after breeding is critical in minimizing embryo loss due to their failure to implant. As much as 25% of the potential lamb crop may be lost during this period. In particular, short periods of severe under-nourishment increase embryo mortality. As well, an excessively high level of nutrition after mating may impair survival. Continued underfeeding of ewes in poor condition at mating (score less than 2) can result in high rates of loss while ewes in good condition (3+) at mating produce more ova with fewer embryo losses even when moderately undernourished in early pregnancy.

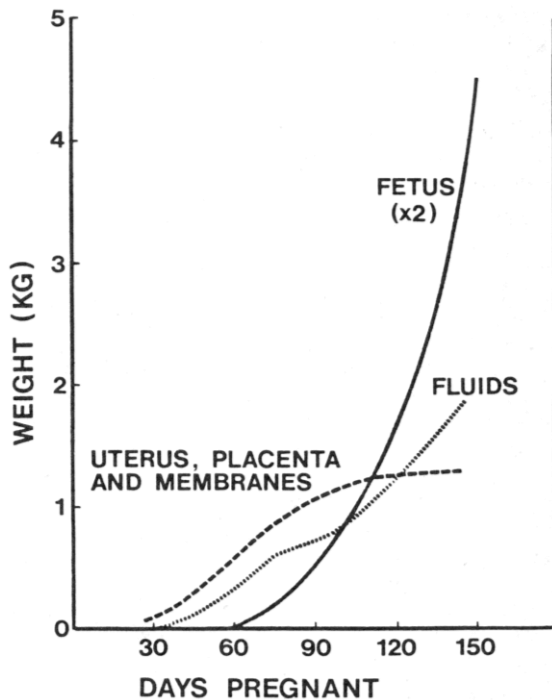

Figure C13 Growth of the products of conception in a ewe bearing twins.

Moderate under-nourishment would imply a 3-4% loss of body weight over the first month to five weeks after breeding.

Ideally, the target for nutritional management in this first month of pregnancy would be maintenance to a slight increase in weight. NRC recommendations suggest a post flushing gain of 0.03 kg (0.07 lbs)/day. As mentioned earlier, it should be appreciated that feeding management is practiced on a flock basis. Figure C12 suggests that flushing continues 3 weeks after the rams are turned in. Therefore, if the suggested targets are realized, ewes bred on the first day might gain somewhat over 3 kg (7lbs) in their first month of pregnancy while those bred on the twenty-first days would gain slightly less than 1kg (2lb).

Mid-Pregnancy (up to 100 days)

By the end of the fifth week after breeding, the developing embryos are well established within the uterus although their weights are insignificant (fig. C13). During the second and third months, the placenta develops rapidly from the initial site of embryo attachment. By 100 days it has reached its ultimate size while the fetuses are less than 20% of their birth rates.

The total weight of the products of conception in the ewe carrying twins is about 3kg (7lbs) at this time. Figure C12 suggests a target liveweight increase amounting to approximately 2kg (4lb) in months two and three, meaning that the ewe has actually lost 1kg (2lb) from her own tissues. Such a loss is tolerable and, in fact, British recommendations suggest that losses of up to 7.5kg (17lb) may have little detrimental effect on ewes in good (3+) condition at the beginning of the period providing that they result from sustained but mild undernutrition. As in early pregnancy, severe undernutrition for even short periods can profoundly affect fetal development as can any degree of undernutrition in ewes who are already in poor condition.

It should be recognized that when weight is lost at any time during the ewe's reproductive cycle, it must ultimately be regained at a later date. In terms of total nutrient requirements, it is more costly to lose and regain weight than to simply maintain it. However, there may be some economic advantage to losing weight at a time when feed costs are high (e.g., during winter) and regaining weight when costs are lower (e.g., on pasture).

Undernutrition in mid-pregnancy has its effects on the growth of both the fetus and placenta. Although good nutrition in late pregnancy may compensate for limited fetal size at the end of the third month, restriction of placental growth may be more difficult to offset. It has been suggested that the birth of small lambs by

apparently well nourished ewes may relate to inadequate nutrition in mid-pregnancy which has inhibited placental development. An underdeveloped placenta is simply unable to deliver adequate nutrients to the fetus in late pregnancy even when the ewe is well fed.

Overfeeding during mid-pregnancy can also be detrimental. Increasing the ewe's condition score above 3.5 at this time is wasteful, resulting in increased feed cost. In addition, an excess of abdominal fat combined with the increased size of the uterus can physically restrict the ewe's feed consumption in late pregnancy. Overfat ewes are particularly subject to pregnancy toxemia in late pregnancy when fat is mobilized to meet increased fetal energy demands which cannot be met through additional feed intake.

Late Pregnancy (last six weeks)

As seen in figure C13, approximately 70% of fetal growth takes place during the final six weeks of pregnancy. In terms of nutrient requirements, this is a very expensive process. In fact, the efficiency with which metabolizable energy is used for fetal gain amounts to only about 13%. This can be compared with the efficiencies of other productive processes in table C3.

Rapid fetal growth with its low efficiency combined with the growth of other products of conception, mammary development, colostrum synthesis and the sizable maintenance requirement result in a substantially increased total nutrient demand. In many ewes this demand cannot be completely satisfied because of either restricted intake or feed costs. As a result, a limited decrease in condition amounting to no more than 0.5 condition score may be accepted. Beyond this, lamb birthweight and viability, milk production and even maternal instinct may be adversely affected. To emphasize a point made earlier, excessively fat ewes which are forced to lose condition at this time are particularly susceptible to toxemia

Although the ewe may lose condition to some extent in late pregnancy, fetal growth may be only minimally affected because of its high *priority for nutrients*. This concept was explained earlier and is illustrated in figure C11.

Nutrient intake in this period can also have a marked effect on the ewe's potential milk production after lambing. Figure C14 shows the results of an experiment where three different levels of energy were

fed to ewes in late pregnancy. Notice the effect that lower energy intakes had on subsequent milk production. There are probably two main reasons for this. First, since 95% of udder development takes place before lambing, inadequate nutrition in late pregnancy may limit the amount of milk-producing tissue which is formed. Second, a high level of milk production is dependent upon the utilization of body reserves. Unless the ewe has maintained adequate reserves through late pregnancy, heavy lactation cannot be sustained.

Poor nutrition in late pregnancy can also affect the onset of lactation. This results in very little milk in the udder at lambing followed by a very slow increase in milk yield.

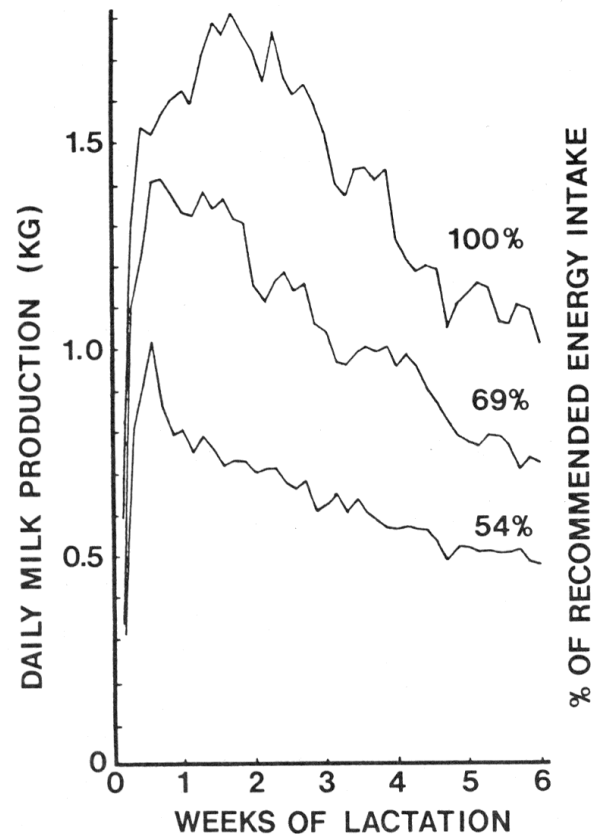

Figure C14 The effect of energy intake during late pregnancy on subsequent milk production.

Lactation

The nutrient requirements of the ewe are higher in lactation than at any other time during the production cycle. In the first four weeks of life, the growth of the lamb is almost totally dependent upon the ewe's milk

production since the nutrient contribution by solid feed during this period is relatively insignificant.

A rough estimate of milk production can be made by assuming a 1:1 conversion of milk dry matter to lamb liveweight gain. For example, twin lambs with a combined average daily gain of 0.6kg (1.3 lb) will be consuming 0.6kg (1.3 lb) of milk dry matter each day. Since ewes' milk is approximately 20% dry matter (compared with the cows' 12%), fluid milk production must be about 3kg (7 lb) daily. Metabolizable energy is utilized for milk production at an efficiency of about 66% (table C3).

Nutrient requirements for lactating ewes are set out in Appendix II. These are based on the NRC recommendation with one important exception. Research done in the U.K indicates that the protein requirements recommended by the NRC may be adequate to sustain milk production when the ewe's milk production potential is limited and little loss in condition score is experienced.

However, in ewes with high potential milk production, maximum feed intake usually cannot supply sufficient nutrients for this potential to be realized. As a result, body reserves may be drawn upon to meet the energy deficit.

In fact, the utilization of body reserves may contribute 25 to 30 percent of energy requirements in the first month after lambing. In order to make efficient use of this process, additional protein should be added to the ration since body protein can contribute very little to milk production. This is another situation where the principle of the *most limiting nutrient* applies. Unless protein is supplied in the ration to complement the energy being drawn from body reserves, much of that energy is wasted. Appendix II suggests supplementary protein levels for ewes at two levels of decrease in liveweight.

It should be obvious that the ewe beginning lactation with a condition score less than 2.5 is in a poor position to realize her potential for milk production.

Non-Nutritional Factors Affecting Milk Production

Ultimately the realization of the ewe's milk production potential depends upon adequate nutrition. However, several other factors may influence both the level and pattern of lactation.

A ewe suckling twins will produce approximately 40% more milk than the same ewe suckling a single. Conversely, a twin lamb will receive only about 70% as much milk as a single. In addition, ewes suckling

twins will reach a higher peak yield usually about three weeks after lambing whereas the lower peak for singles occurs two to three weeks later. As might be expected, the decline in production with twins is faster after the peak has been reached (fig. C15).

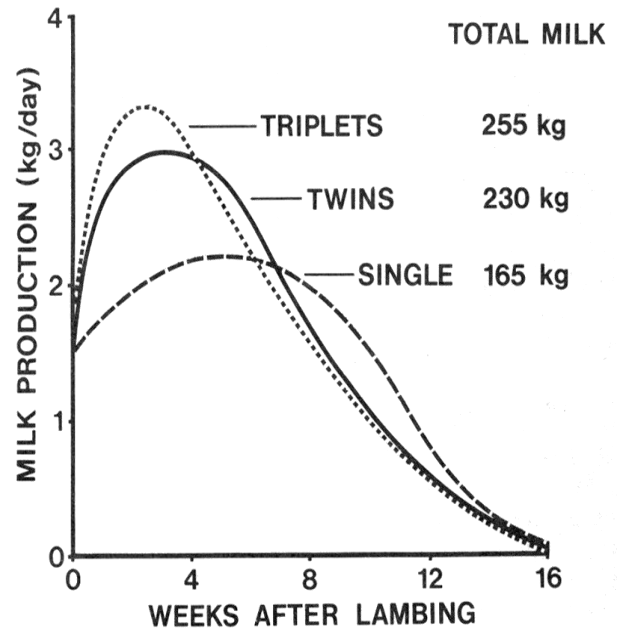

Figure C15 Potential milk production in ewes nursing singles, twins and triplets.

Ewes suckling triplets will produce approximately 10% more than those with twins. Again it follows that triplet lambs will receive only slightly more than 50% as much milk as a single.

In addition to the number of lambs nursing, their size and vigour and, thus, the demands they place on the ewe will affect milk output.

The age of the ewe will also affect her milk production, with the maximum potential being reached at the third lactation and extending usually to the sixth. Yield in the first lactation will be approximately 80% of the mature yield with the rate of decline in later years being affected by nutrition, health and dentition.

Milking Sheep

With the increasing availability of milking sheep genetics from Europe, several producers in B.C. have begun marketing ewe's milk. In most cases, lambs are allowed to nurse for 30-50 days at which time they are weaned and the ewe is milked by machine. Figure C16 compares lactation patterns when dairy ewes are managed in this way versus allowing lambs to continue nursing or exclusive machine milking.

Notice the increased productivity realized with suckling followed by machine milking.

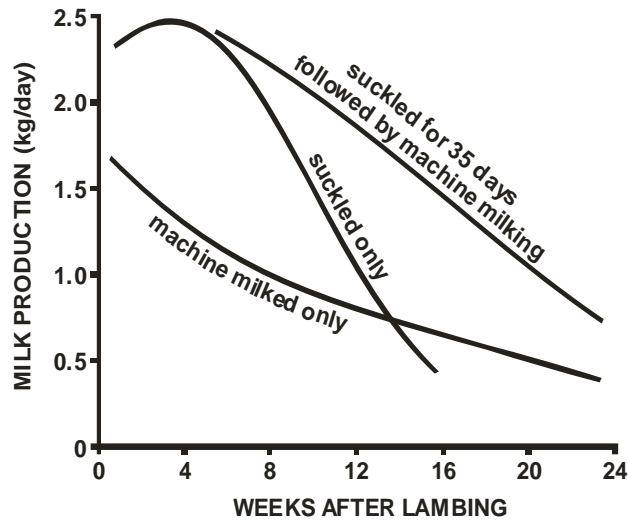

Figure C16 Dairy ewes are normally allowed to nurse their lambs for 30-50 days.

Separate Feeding of Ewes with Multiple Lambs

The nutrient requirements of ewes with multiple lambs are significantly higher than those with singles. In terms of efficient utilization of feed resources, therefore, ewes should be grouped and fed according to requirements. Otherwise, either twin suckling ewes are being underfed, or singles overfed. The practice of further segregating ewes with triplets into groups of five to ten in a small area has become common practice in highly prolific flocks. This permits an extra high level of feeding, facilitates interaction between ewe and lambs and reduces dependence on expensive milk replacer.

Because the milk production of ewes suckling multiple lambs peaks earlier and declines faster, an extra effort should be made to introduce their lambs to creep feed. This practice will assure the continued efficient growth of these lambs.

Special Requirements of Ewe Lambs

The discussion above has focused on the requirements of the mature ewe. However, 15-20% of the ewes in a productive commercial flock will be ewe lambs. Economics demand that these animals be bred to lamb at twelve to fifteen months of age since it is extremely difficult to recover the cost incurred in raising females to two years of age before their first lambing.

With the goal of first-year lambing in mind, the nutritional management of these ewe lambs is critical if their full productive potential is to be realized. Their pre-breeding nutrition will be discussed in the section on Nutrient Requirements of Lambs where the objective is to grow them out to 75% of their expected mature body weight with a condition score of 3.5. If these objectives are not realized, it may be next to impossible to maintain condition in late pregnancy and to stimulate sufficient milk production to meet the growth requirements of the offspring.

It is common practice to delay the breeding of ewe lambs by two or three months behind the main flocks. This is advantageous for a number of reasons:

- (1) It allows extra time for growth;
- (2) It usually means higher conception rates especially when a high proportion of white-face breeds is present since they tend to reach puberty somewhat later than Finns or the Down breeds;
- (3) It allows available ram power to be spread out more efficiently (ewe lambs should be mated to mature, experienced rams); and
- (4) At lambing time special attention can be given to the frequent problems associated with ewe lambs.

This practice also has a few disadvantages:

- (1) Mothering problems which arise with ewe lambs cannot be as easily solved because experienced foster ewes are unavailable.
- (2) If lambing of these young ewes is delayed too long, other time conflicts may arise (e.g. spring field work).
- (3) Colostrum will have to be stored frozen since few ewe lambs will have an excess supply to share with those who produce too little.

Targets for Ewe Lambs

Figure C17 suggests targets for ewe lambs. The main difference in liveweight gains applies to early and mid-pregnancy when a sustained increase should be seen. This is because, in addition to growth of the products of conception, it is expected that the ewe lamb will gain a further 10-15% of her mature body weight.

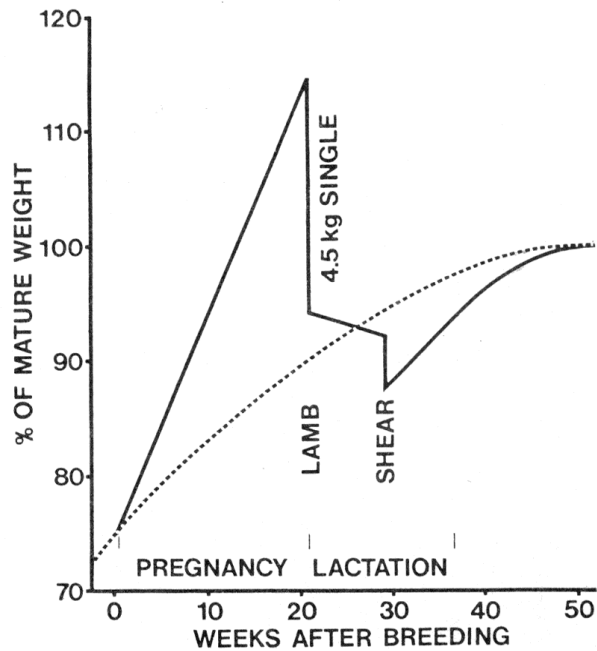

Figure C17 Liveweight targets for ewe lambs assuming a breeding weight equivalent to 75% of expected mature weight and a condition score of 3-3.5 at mating. The dashed line represents the growth of the non-pregnant ewe lamb.

With the rapid growth of the fetus in late pregnancy there is little opportunity to make a contribution to the ewe lamb's own body at this time. Appendix II recommends increased TDN and CP intakes to accommodate these requirements.

Ewe lambs are more susceptible to the effects of under-nutrition on embryo loss. It is therefore particularly important that feeding levels be maintained after breeding.

NUTRIENT REQUIREMENTS OF LAMBS

Nutrient requirements for lambs are given in Appendix II, which is the recent publication on nutrient requirements for sheep.

Before discussing the feeding of lambs at various stages of development, any explanation of the growth process and some of the factors influencing growth is in order.

How Lambs Grow

A typical pattern for the growth of a lamb on full feed from birth is shown in figure C18. Tentative growth during the first week or two is followed by a rapid increase in growth rate which declines as the lamb ages. Although the absolute limit of growth rate is genetically determined, in practice gain is usually limited by nutrient intake. Inadequate milk during the first month of life can prolong the tentative early growth phase. Later, nutrient intake may be restricted by feed of low nutrient quality or limited availability of feed (e.g., overstocked pasture). The effect of limited nutrient intake is to prolong the feeding period to market by reducing the relative amount of nutrients available for gain.

Feed Intake

Figure C19 gives rough guidelines for *ad lib* feed intakes of lambs. Dry feed intake is normally insignificant prior to three weeks of age. However, intake can be significantly influenced by a well executed creep-feeding program. This topic is discussed in detail later. Although intake will normally vary between 3.5 and 4% in feeder lambs, total dry matter intake does not increase linearly with weight

when high concentrate diets are fed. It was found that intake increased to a peak six weeks after going on feed and then reached a plateau. Actual intake will also depend upon size, condition, age and whether the lambs are growing to compensate for a previous period of undernutrition.

Other factors which influence intake include:

- (1) amount of feed offered;
- (2) competition for available feed;
- (3) palatability;
- (4) physical form of feed (long, chopped, rolled, pelleted, etc.);
- (5) ease of harvesting (pastures);
- (6) energy and fibre content of feed (p. 20);
- (7) ambient temperature and humidity (p. 21);
- (8) availability and quality of water.

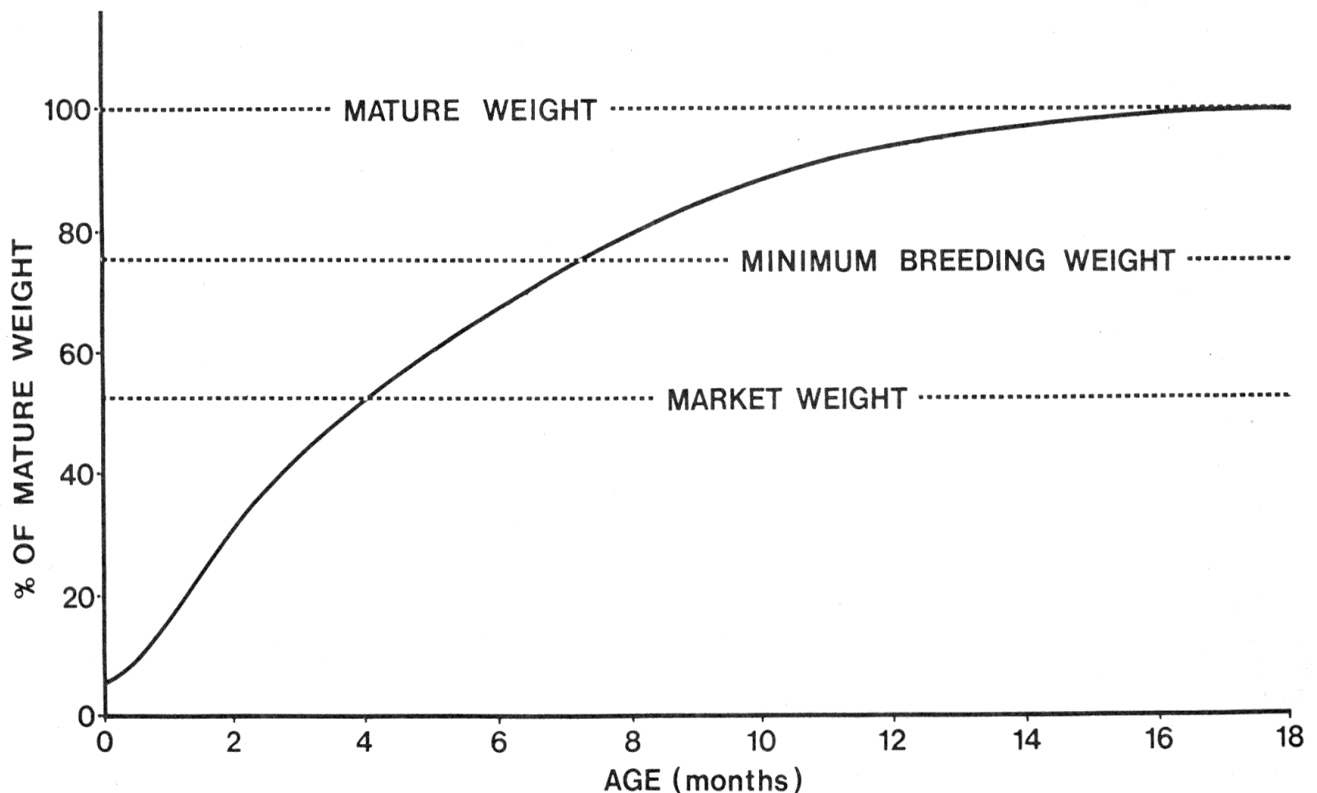

Figure C18 Typical pattern of lamb growth when nutrient requirements are fully satisfied.

It should also be recognized that what is assumed to be intake often includes a good measure of waste.

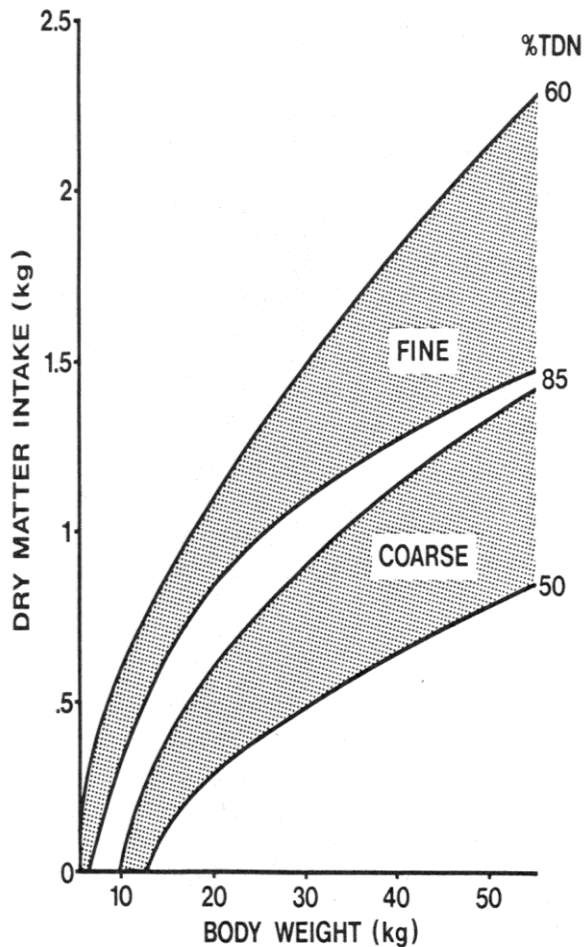

Figure C19 *Ad lib* feed intakes for lambs. Fine rations include concentrates as well as milled and pelleted roughages. Coarse feeds consist of long or chopped roughages, silages and grazed herbage. Within these two ration types, intake is markedly affected by the energy (TDN) concentration in the feed (see page 20).

Maintenance and Gain

Earlier, the concept of *priority for nutrients* was introduced. The lamb's daily nutrient intake is partitioned between a requirement for maintenance and a requirement for gain. The priority requirement is for maintenance with any remaining nutrients being available for gain. Clearly, when nutrient intake is just sufficient for maintenance no growth occurs. If this continues, the lamb will never reach market weight. Conversely, the fastest gains occur when lambs are fed high quality feed to appetite (*ad lib*) because, here, a high proportion of intake is available beyond the

requirement for maintenance. This is illustrated in figure C10.

TABLE C10 Average daily gains for recorded purebred lambs on in Canada. Based on 50 and 100 day weights adjusted for sex, weaning number (single, twin, etc.) and age of dam.

Breed	Average Daily Gain 50-100 days (kg)
Suffolk.....	0.34
Hampshire.....	0.32
Columbia.....	0.31
Rambouillet.....	0.30
NC Cheviot.....	0.27
Oxford.....	0.27
Leicester.....	0.25
Dorset.....	0.24
Landrace.....	0.22
Southdown.....	0.18

Breed Variation

Marked variability is seen between the growth rates of common breeds. Table C10 gives 50 to 100 day average daily gains for lambs on ROP in Canada. Figure C20 compares the growth curve of a typical Suffolk ram lamb with that of a typical Dorset. The rate of decline in average daily gain as a lamb ages is a reflection of its ultimate mature size.

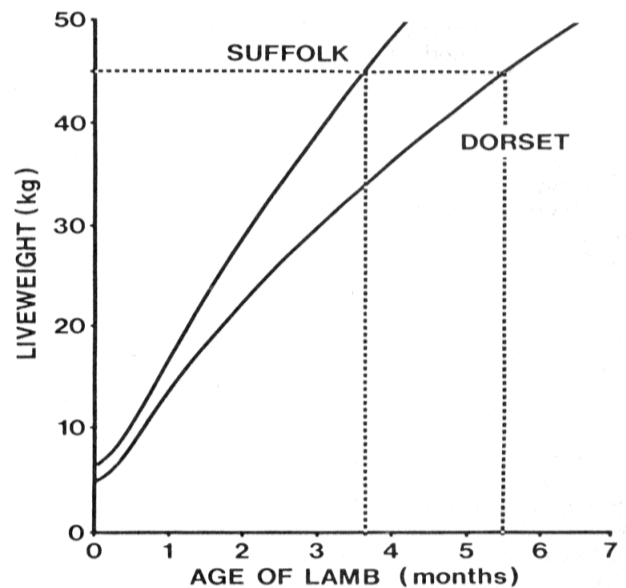

Figure C20 The effect of breed on the growth of ram lambs. The dashed lines show times taken to reach a market weight of 45kg.

Difference in growth rates between breeds is partially due to differences in feed consumption. In addition, breed differences for gain are influenced by the efficiencies of feed utilization for fat and lean deposition. Fat has an energy content 2.25 times that of lean so that average daily liveweight gain is lower when fat is being deposited.

In terms of the choice of breeds for market lamb production, the Meat and Livestock Commission in the U.K. suggests that optimum slaughter weight is about one-half of mature weight. To project an optimum slaughter weight for a group of crossbred lambs, the mature weight of the ram breed added to the mature weight of the ewe breed can be divided by four.

In general, large breeds like the Suffolk and Hampshire grow faster and produce a heavier carcass at a given degree of fatness than smaller breeds like the Dorset or Southdown and hair breeds like St. Croix and Barbados Blackbelly. Conversely, if Dorsets and Suffolks are slaughtered at the same weights, the Dorsets will be fatter than the Suffolks. There are, of course, exceptions to these rules. For example, the Columbia breed, although larger than the Dorset at maturity, takes significantly more time to get there.

Effect of Sex

Ewe lambs have significantly lower voluntary feed intakes than either rams or wethers. In addition, female lambs deposit more fat in their gains than males. As a result, female lambs grow more slowly and are less efficient converters of feed to liveweight gain. The same degree of fatness will be obtained with rams 10% above, wethers 5% above and ewes 10% below the optimum slaughter weights calculated earlier.

Ratio of Fat to Lean

The amount of fat deposited in the carcass is proportional to the rate of gain. Within breed type and sex, fast growing lambs will reach a given degree of finish before those which grow more slowly. Again, fat is relatively costly to grow since its energy content is higher and its water content lower than lean.

Stages of Lamb Growth Pre-Weaning

As mentioned earlier, in the first weeks of life, the growth of the lamb is absolutely dependent upon the ewe's milk production. The process is relatively efficient with an average 66% of the metabolizable energy consumed by the ewe being converted to milk

energy followed by an almost 100% efficient process of conversion of milk solids to lamb liveweight gain. Lambs can compensate for inadequate milk supply to some extent by increasing consumption of solid feed. However, it is important to realize that:

- (1) significant amounts of solid feed cannot be consumed before two to three weeks of age;
- (2) the solid feed consumed will in no measure compensate for inadequate milk unless it is of high quality; and
- (3) approximately 3-5 units of feed dry matter intake is required to replace 1 unit of milk dry matter because of the high digestibility of milk and the efficiency with which it is used for growth.

Rumen development is accelerated as the lamb consumes solid feed. This was discussed earlier in the section on the The Sheep Digestive System (p.10). As lactation progresses, the efficiency of converting feed through the ewe declines and with the lamb's ability to convert dry feed increasing, weaning may be considered as early as three weeks after birth although the lamb is not fully ruminant for another 1-2 months.

Weaning cannot be considered unless the lambs are consuming at least a half pound per day of nutritious dry feed. If this precaution is not observed a serious setback in growth may occur requiring a two to three week period for recovery. Weaning practices are discussed later (p.57).

Finally, the young lamb cannot be expected to utilize non-protein nitrogen efficiently until it is fully ruminant at about three months of age. Therefore, urea has little place in creep rations for lambs or in rations for early weaned lambs.

Post Weaning

As mentioned, weaning may produce a setback in growth in some lambs. This setback can be minimized by making the transition to independence as smooth as possible. It is often advantageous to move the ewes away from the lambs so that the lambs continue to have access to the pre-weaning creep ration in familiar surroundings until independence is well established.

On the basis of work done by Dr. Malcolm Tait at the University of British Columbia, it has been recommended that concentrate rations for lambs be based on whole barley supplemented with a 32% protein supplement pellet. The use of these

ingredients makes it very simple to adjust ration protein levels by altering the proportions of barley to supplement. This will be discussed more fully later (p.59). Whatever rations are used for growing lambs, care should be taken to assure smooth transitions from one to the next. Often a heavy penalty is paid when lambs lose performance by going off feed.

The rations fed to weaned lambs will depend upon the age of the lambs at weaning. Lambs weaned at 25-35 pounds tend to gain at an accelerating rate with increased weight. They will gain 15 to 20 per cent faster and will consume one to two percent more feed per unit of body weight than older lambs full-fed a high energy diet. In fact, it is important to recognize that the potential feed conversion efficiencies of young lambs is much greater than lambs reaching the end of their feeding periods. Table C11 gives guidelines to these decreasing efficiencies. The reason for this lies in the fact that maintenance requirements increase with body size. The practical importance is that it is much more efficient to feed a pound of grain to a two month old lamb than to a six month old lamb.

TABLE C11 Feed efficiency decreases as lambs increase in age. These are rough estimates which will vary with energy content in ration and many other factors.

Age in Months	Feed Efficiency (kg feed:kg gain)
2	2:1
3	3:1
4	4:1
5	5:1
6	6:1
7	7:1

Finishing

The traditional market demands a finished lamb yielding a carcass of 40-50 pounds. Although many lambs have the ability to grow well beyond these limits without becoming excessively fat, an equal number tend to be over finished even at the lower end of the range. It is important, therefore, to be able to assess market readiness in the live lamb. To this end, a method of condition scoring market lambs is described later under Feeding Management (p.48).

The annual lamb price cycle in North America (Figure C21) has had an effect on lamb feeding strategies as well as decisions affecting lamb season. Winter-born

lambs are usually put on full feed to reach market before prices decline in early summer.

Late born lambs, often pastured until September and October, are often finished in dry lot during the fall and winter. It is not an uncommon practice to attempt to prolong this feeding period in order to market lambs in February and March when prices are high.

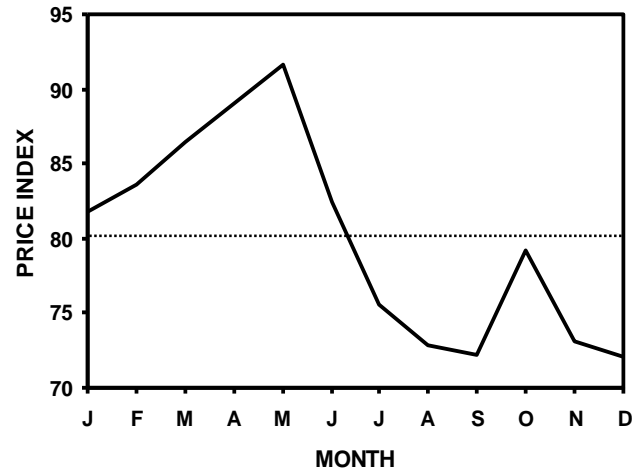

Figure C21 A annual lamb price cycle 1979-2002.

This is risky business, in view of what has been said about maintenance requirements. Unless feed costs are very low, the increase in market price has to be significant to offset the extra feed cost incurred in prolonging the finishing period.

Urea may have some application in lengthy finishing periods. It was suggested that a two-week adaptation period is required before non-protein nitrogen is utilized efficiently. The resultant production penalty usually outweighs the price advantage for lambs full-fed high energy rations. However, when urea is fed over a two to four month period, the significance of the period of adaptation is reduced. Under these conditions lambs can efficiently utilize urea at a level of 1% of the ration dry matter which would contribute an additional 2.5-3% equivalent crude protein (ECP) to the finishing ration. As suggested earlier (p.16) a readily fermentable source of carbohydrate must also be available.

Growing Replacement Ewe Lambs

It is often suggested that replacement ewe lambs should not be full-fed high-concentrate rations because of its long-term effect on reproduction and longevity. It has already been pointed out that rapid gains are associated with increased fat deposition. However, under most management conditions there is little risk in growing out replacement ewe lambs

alongside market lambs at least until they reach 50% of their expected mature body weight.

In fact, it is important to do this in order to make an objective assessment of the merit of prospective flock replacements. When a performance appraisal program is used, all lambs should be raised under similar conditions until the 100-day test is done. On the basis of performance index together with other criteria, replacement lambs should be selected and further grown out on high quality forage based rations. The objective should be to reach a minimum 75% of mature body weight at a condition score of 3.5 in time for mating.

NUTRIENT REQUIREMENTS OF RAMS

In the commercial flock, rams are frequently purchased as ram lambs at 6-8 months of age. Under these circumstances there are two critical periods in meeting the nutrient requirements of flock studs.

- (1) From the time they are purchased until they reach mature size; and
- (2) Before and during the breeding season.

Any ram worth purchasing should have achieved 50% of its mature body weight at six months of age. The projected mature body weights of rams purchased as meat sires should be well above the average for rams of that breed. For example, the average mature Suffolk ram in Canada weighs about 120kg (265 lb). If a Suffolk ram is purchased as a terminal meat sire, its potential mature weight should be at least 140kg (309 lb) meaning that its weight at 6 months should be minimum 70kg (154 lb).

Rams purchased as sires for replacement ewe lambs are of course, selected on other criteria, but to achieve adequate breeding status in the first year, they too should be 50% of their expected mature weight at 6 months of age.

As was the case for replacement ewe lambs, the breeding target from ram lambs is 75% of mature weight at a condition score of 3.5. After purchase or selection from within the home flock, steady growth on high-quality forage based rations is the goal. Ram lambs should not be expected to mate with more than 25 ewes (during a 3 week breeding session) in their first season. On completion of the first breeding season, ram lambs should continue to be grown out on quality forage to reach 95% of their ultimate size by the second breeding season.

From this point on, rams are simply maintained during most of the year. However, they should be managed much as the ewe flock is managed prior to the breeding season. Hooves should be trimmed, testicles checked for swelling, the penis for any abnormalities. External and internal parasites should be controlled and a survey of overall health and function conducted. When the ewes are flushed, the nutrient intake of the rams must be increased as well. Rams which are conscientious about their function may lose a full condition score during a three to four week breeding cycle. A ram with a very strong libido may have to be removed from the ewe flock for short periods of feeding.

Nutrient allocations for rams are suggested in Appendix II.

SECTION D – FEED TESTING AND RATION FORMULATION

Many of the forages grown in B.C. are of insufficient quality to meet the minimum requirements of our livestock. For example, a significant proportion of our grass hays have crude protein levels in the 4-7% range while 9% CP is considered minimal for ewe maintenance.

Unless the nutrient content of feeds is known, their allocation to meet productive requirements is pure conjecture. Undernutrition is detrimental to productivity while overnutrition is a waste of valuable feed resources. Maximum dollar returns demand that animal requirements be matched by nutrient intake. This can only be accomplished when nutrient levels in feed have been determined through feed testing.

FEED SAMPLING

Feed testing involves both *sampling* and *analysis*. Often the importance of the former is underestimated. A feed testing laboratory can only analyze what is submitted and unless the sample is representative of the available feed supply, the time and money spent will be wasted.

For example, a bale is thrown from the top of a haystack, the strings are cut and a handful of hay is pulled from the centre, put in a plastic bag and sent in for analysis. Several sources of sampling error are possible:

- (1) Perhaps the bale, being on top of the stack, was one of the last baled. Did that part of the swath receive more rain than that baled earlier? Had it dried more, resulting in greater leaf shattering? Was it from a corner of a field not typical of the rest?
- (2) As a result of being on top of the stack was the sample bale more weathered? Had the stack received rain?
- (3) In pulling hay from the bale, were leaves stripped off resulting in a sample which had a high proportion of stems?

The goal of feed sampling is to obtain a sample which is *representative* of the average feed value of the bulk of feed from which it is taken. If there is reason to believe that significant differences exist between one

batch of feed and another, then representative samples should be drawn from each batch separately.

Sampling Hay

A convenient coring tool (fig. D1) is available for sampling hay. A stack should be sampled in 10 to 15 different locations, well distributed around the stack (fig. D2). Additional cores will result in a more representative sample. The cores should be thoroughly mixed in a plastic bucket and from this a sub-sample should be taken for submission. Care should again be taken to ensure that the sub-sample is representative of the bulk of material in the bucket. A second sub-sample should be saved in case a question arises out of the analysis results.



Figure D1 Hay coring tool.



Figure D2 Haystack sampling.

Sampling Silage

Horizontal silos should be sampled on the cut face since coring with a short sampler results in a sample more representative of surface spoilage than the bulk of silage within. An extended corer may be available, allowing samples to be taken from some distance into the pit. The power requirements of these may limit their use to sites where electricity is available. A third alternative for sampling silage pits is to manually dig into the silage at several sites. Care should be taken to repack these sites to avoid excess spoilage. Ten to fifteen samples should again be taken, mixed and subsampled. Silage submissions should be sealed in plastic, evacuating as much air as possible. An additional precaution against spoilage would be to freeze and insulate the sample before mailing. Unless these steps are taken, the introduction of air into the sample can result in a product arriving at the lab which is quite different from that removed from the silo.

Sampling Grain and Mixed Feeds

Dry feeds stored in bulk can be sampled by plunging an arm into the feed and sampling at least 10 different sites. If the feed is bagged, samples should be taken from five to ten individual bags.

Nutrient concentrations in grains are much less variable than those in forages. In many cases, such as when grain is purchased in small loads, "book values" may be used. These can be found in Appendix II. On the other hand, nutrient levels in screenings and other by-products are impossible to predict. They should be sampled and submitted for analysis.

Interpretation of Analysis Reports

Feed analysis procedures are described in Section A. It should be appreciated here that some degree of judgment must be used in interpreting results. Spurious results may be due to sampling error, to lab error or to contamination. On receiving analysis from the feed lab, first compare with the average results given in Appendix II. Levels which seem grossly out of range should be questioned and a second sample should be submitted. If other samples have been submitted in the past, these should be compared with the current results.

RATION FORMULATION

Ration formulation amounts to matching available feed resources to the requirements of each class of livestock and stage of production. Clearly, this can

only be done when feed quality has been measured and requirements are known. Using the average analysis of typical B.C. feeds in Appendix I and the requirements for lactating ewes in Appendix II, several examples will serve to demonstrate methods for ration formulation.

TABLE D1 Analysis of available feed used in example 1.

Nutrient	Nutrient Levels (DM basis)		
	hay	barley	protein supp.
	----- per cent -----		
TDN.....	58.0	83.0	80
Crude Protein.....	12.2	11.5	32
calcium.....	0.91	0.11	3.5
phosphorus.....	0.21	0.32	2.0
magnesium.....	0.28	0.16	0.3
potassium.....	0.61	0.37	2.5
	----- mg/kg -----		
copper.....	5.0	12.0	2.0
molybdenum.....	2.0	2.0	0
maganese.....	61.5	25.9	400
zinc.....	25.3	51.1	25
selenium.....	0.07	0.1	0.1

Example 1 – Pearson Square

A 70 kg (154 lb) ewe nursing twins in early lactation requires 1.82 kg (4.0 lb) of TDN per day. She can consume 2.8 kg (6.2 lb) of dry matter per day and, therefore, a ration containing 65% TDN (1.82 divided by 2.8) will satisfy her energy requirement. Table D1 gives the analyses of available feeds. The question is: how much of each of these feeds should be fed to satisfy her requirements?

A simple method of calculating this is called the *Pearson Square* and the technique is demonstrated below. All quantities and proportions will be expressed on a dry matter basis:

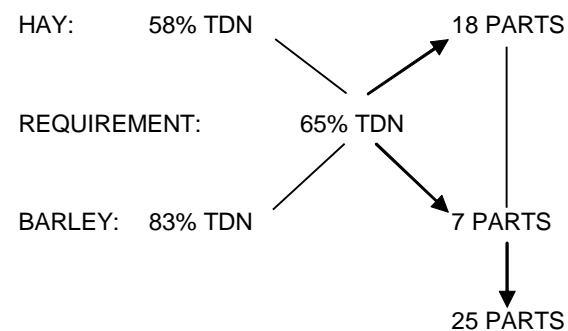

The energy levels in the ingredients are set out on the left side with the required level in the centre. Subtraction across the diagonals gives the proportion of each to be used in the daily ration. In this case, an 18:7 ratio of hay to barley should be fed, amounting to $(18/25 \times 2.8) = 2.0\text{kg}$ (4.4 lb) of hay and $(7/25 \times 2.8) = 0.78\text{kg}$ (1.73 lb) of barley.

Of course, we have only balanced the ration for one nutrient: energy. It is now necessary to check the levels of some of the other major nutrients including crude protein, calcium and phosphorus.

For example, if our ewe requires a ration containing 15% CP, 0.39% Ca and 0.29% P. Clearly, no level of either of the available ingredients will supply the required level of protein since both hay and barley are deficient. In this situation, protein supplement is required and in order to calculate the amount required, the Pearson Square can again be used. The crude protein level of the hay: barley ration is calculated:

$$\%CP = \frac{\begin{array}{cc} \text{hay} & \text{barley} \\ \%CP \text{ parts} & \%CP \text{ parts} \end{array}}{\text{sum of parts}} = \frac{(12.2 \times 18) + (11.5 \times 7)}{25} = 12\%$$

This figure is used on the left side of the new Pearson Square along with the crude protein level of the protein supplement:

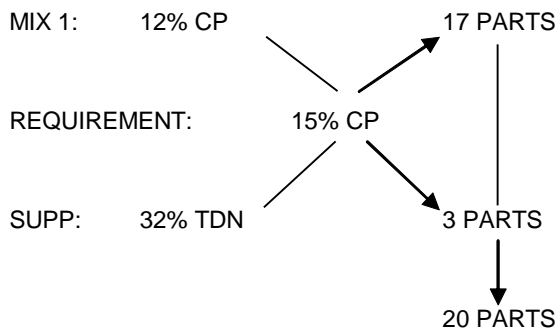

Calculating as before suggests that 17 parts of the hay-barley ration combined with 3 parts of 32% protein supplement will satisfy requirements for protein. The relative proportions of the three ingredients will now be:

hay: $17 \times 18/25 = 12.2$ parts
 barley: $17 \times 7/25 = 4.8$ parts
 supplement: 3.0 parts
 TOTAL: 20.0 parts

In terms of kg of feed this is equivalent to daily intakes of:

hay: $12.2/20 \times 2.8 \text{ kg} = 1.71 \text{ kg}$

barley: $4.8/20 \times 2.8 \text{ kg} = 0.67 \text{ kg}$
 supplement: $3/20 \times 2.8 \text{ kg} = 0.42 \text{ kg}$

In actual feeding practice, supplement would be mixed with whole grain in a 3:4.8 ratio and 1.09 kg (2.4 lb) would be fed per ewe per day.

Notice that supplement has replaced 0.42 kg (.93 lb) of the hay-barley mix formulated earlier. This is because the ewe is still limited to consuming 2.8 kg (6.2 lb) of total ration. But since the supplement is likely to be higher in energy (about 80% TDN) than the 65% TDN level of the hay-barley ration, the total ration will be slightly higher in energy. In fact, the TDN level in the three-ingredients ration can be calculated:

$$\% \text{TDN} = \frac{\begin{array}{ccc} \text{hay} & \text{barley} & \text{supp} \\ (58\% \times 12.2) & + & (83\% \times 4.8) & + & (80\% \times 3) \end{array}}{\text{sum of parts} \times 20} = 67.3\%$$

This points out the main limitations of the Pearson Square method. It can really only be used accurately to balance the levels of two ingredients for a single nutrient. Beyond this the technique becomes cumbersome and other methods, to be discussed later, should be used.

The lactating ration can, however, be further balanced using a little simple arithmetic. First, the calcium and phosphorus levels and their ratio in the three ingredient ration should be checked:

$$\%Ca = \frac{\begin{array}{ccc} \text{hay} & \text{barley} & \text{supp} \\ (.91\% \times 12.2) & + & (.11\% \times 4.8) & + & (3.5\% \times 3) \end{array}}{\text{sum of parts} \times 20} = 1.11\%$$

Ca requirement = 0.39%

$$\%P = \frac{\begin{array}{ccc} \text{hay} & \text{barley} & \text{supp} \\ (.21\% \times 12.2) & + & (.32\% \times 4.8) & + & (2.0\% \times 3) \end{array}}{\text{sum of parts} \times 20} = .50\%$$

P requirement = 0.29%

There is no need in this case to supplement with either calcium or phosphorus.

The ration levels of other essential minerals should also be checked. The requirements for these are given in Appendix II and in table D2 where they are compared with the levels in the mixed ration. The latter are calculated in the same way as the Ca and P levels above.

Notice that the mixed ration has adequate levels of all minerals except zinc and selenium. In addition, although the absolute level of copper seems adequate, the copper:molybdenum ratio is low. This will result in a decreased availability of copper and, since the copper level is only marginally adequate, supplementation is required.

Zinc, selenium and relative copper deficiencies are common in British Columbia. When calcium and phosphorus levels are adequate, the most practical form of supplementation is in the form of free-choice trace mineralized salt with selenium. A typical analysis of these products is shown in figure C7. The following formula can be used to calculate the amount of supplement intake required to make up ration mineral deficits:

$$\text{Supp intake (grams)} = \frac{\text{deficit} \times \text{DM intake} \times 1000}{\text{level of mineral in supplement}}$$

TABLE D2 Mineral requirements and levels in example 1 mixed ration.

Mineral	Mineral Levels (DM basis)	
	Requirement	Mixed Ration
	----- per cent -----	
calcium	0.39	1.1
phosphorus	0.29	0.50
Ca/P	1-5	2.2
magnesium	0.18	0.25
potassium	0.8	0.84
	----- mg/kg -----	
copper	5	6.2
molybdenum	0.5	1.7
Cu/Mo	5.0	3.6
manganese	40.0	104
zinc	33.0	20.0
selenium	0.20	0.08

The units (either % or mg/kg) used for the deficit must be the same as those used for the level of mineral in the supplement. For example, in the case of selenium, the deficit is the 0.2mg/kg requirement minus the 0.08 mg/kg in the total ration which is equal to 0.12 mg/kg:

$$\text{supplement intake} = \frac{.12 \times 2.8 \times 1000}{25} = 13.4 \text{ grams}$$

Similarly, the supplement intake requirements for zinc and copper can be calculated. Notice that the copper requirement is 8.5 mg/kg when the ration molybdenum level is 1.7 mg/kg (5 x 1.7 = 8.5).

Mineral	Required	Ration Level	Deficit	Supp. Intake
selenium.....	0.2	0.08	0.12	13.4
copper	8.5	6.2	2.3	19.5
zinc.....	33	20	13	9

The table above indicates that an intake of 19.5 grams (0.7 ounces) per ewe per day of TM salt with selenium would be required to completely satisfy mineral requirements.

Example 2

Now, assume that the grass-legume hay available had a protein level of 16.5%, with TDN, Ca and P levels remaining the same. Since a hay:barley ratio of 18:7 would result in a ration balanced for both TDN and protein, there would be no need to add protein supplement. Calcium and phosphorus levels can be calculated as before:

$$\% \text{ Ca} = \frac{(.91 \times 18) + (.11 \times 7)}{25} = .69\%$$

$$\% \text{ P} = \frac{(.21 \times 18) + (.32 \times 7)}{25} = .24\%$$

Notice that the mixed ration is deficient in phosphorus and, therefore, supplementation is required. In this case, TM-salt with selenium is of no use since it contains no phosphorus. A complete mineral mix such as that described in figure C8 is required. Since the ration calcium level is adequate, the use of a mineral containing calcium might be questioned. In fact, mineral supplements containing only phosphorus are available in some areas but, in many cases, sheep find them unpalatable and will not consume sufficient quantities to meet their requirements. Their low palatability is a result of the source of phosphorus used. Although more palatable sources are available, they are not commonly used because of their cost and the fact that other types of livestock are not as particular as sheep.

The formula introduced earlier can be used to calculate the supplement intake required:

$$\text{supplement intake} = \frac{.05 \times 2.8 \times 1000}{17} = 8.2 \text{ grams}$$

And now, as before, the ration levels of other essential minerals should be checked (table D3).

TABLE D3 Mineral requirements and levels in example 2 mixed ration.

Mineral	Mineral Levels (DM basis)	
	Requirement	Mixed Ration
	----- per cent -----	
calcium.....	0.39	0.69
phosphorus.....	0.29	0.24
Ca/P.....	1-5	2.5
magnesium.....	0.18	0.25
potassium.....	0.8	0.54
	----- mg/kg -----	
copper.....	5	7.0
molybdenum.....	0.5	2.0
Cu/Mo.....	5	3.5
manganese.....	40	52
zinc.....	33	20
selenium.....	0.2	0.08

Notice that the selenium and copper (relative to molybdenum) levels in the total ration are deficient. These minerals may be supplemented in a TM salt with selenium as before. In this case, it is usually advantageous to mix the loose TM salt and mineral supplement together and offer the mix free choice. The animals' desire for salt will usually ensure consumption of the mineral when this is done. In practice, it is often difficult to ensure that adequate mineral supplements are consumed when offered free choice. This will be discussed later in the section on feeding management.

An alternative to TM salt as a source of copper in the present example would be to use a mineral mix which has a copper level in the 0.07-0.1% range. Because of the real possibility of copper toxicity it is unwise to use supplements having copper levels in excess of 0.1%

Selenium may also be supplemented in alternative forms. Some veterinarians carry selenium premixes which can be added to salt or mineral mixes, to complete rations or as a topdressing when feeding grain. Selenium may also be supplemented by intramuscular injection as suggested earlier.

Computerized Ration Formulation

The limitations of the Pearson Square method were mentioned earlier and the manual arithmetic methods used in the previous examples could clearly become tedious if any number of rations are being formulated. For the average producer, however, they are adequate and using them should result in a good understanding of the processes involved. In fact, after having manually formulated a few rations, the procedure will become increasingly simple.

Rations can also be easily formulated using a computer. Several sheep ration formulation programs are available, including:

- the ARIES program from the University of California, Davis -<http://animalscience.ucdavis.edu/extension/aries.htm>
- the ASI Sheep Ration Balancer from Kansas State University – http://www.oznet.ksu.edu/dp_ansi/software/sheepprat.htm
- OviRation from SoftAgro - <http://www.softagro.com/oviration.html>

Alternatively rations can be formulated using a spreadsheet program such as Microsoft Excel®.

Ration Recipes

Novice sheep producers often ask questions such as:

- How much hay should I feed my sheep?
- What kind of mineral should I use?
- Do I need to administer injectable selenium?

Simple answers are expected: 4 pounds, 1:1 mineral, yes.

Having come this far, it should be obvious that if simple answers are going to be given, then the widest margin of safety must be allowed. However, in commercial livestock production, wide safety margins are usually reflected in narrow profit margins. During maintenance, a ewe may only require 2.5 pounds of hay of mediocre quality. To feed four pounds is simply wasteful. The calcium and phosphorus in a 1:1 complete mineral may not be required when protein supplement is already being fed. Injectable selenium is superfluous when adequate amounts of TM salt with selenium are being consumed.

Nevertheless, as long as the constraints are recognized, prototype rations can be suggested. A number of these are given in Appendix III.

SECTION E – FEEDING MANAGEMENT

Previous sections have dealt with the fundamental concepts of sheep nutrition. It is essential that these be well understood in order to put them to practical use. Feeding management deals with the application of these fundamentals to the producer's individual production goals. Once rations are formulated, it is often the way in which they are fed which determines the success of an operation. The same is true when pastures are a primary source of nutrients. In this case, the producer's skill in grazing management may be more important to overall productivity than the quality of the pasture itself.

This section encompasses a wide variety of management topics, with the ultimate goal of applying the principles of nutrition discussed earlier to the efficient and profitable production of lamb.

CONDITION SCORING EWES

Every producer will have developed some method of assessing the nutritional status and amount of fat carried by individuals in the flock. Excess fat on the back of a ewe constitutes an unproductive expense. Fat is expensive to put on and expensive to maintain. On the other hand, some amount of fat is essential as insulation and as an energy store for times of energy demand beyond that which can be supplied in the feed.

The degree of fat cover is an indication of animal's *condition*. However, it is difficult to visually assess the condition of a ewe in winter since she is covered in wool. *Condition scoring* has been widely accepted as a simple manual method of estimating nutritional status. Condition scoring is achieved in much the same way as lambs are appraised for their readiness for market. In a thin animal, the bones of the spine protrude quite prominently. When excess fat is present it is difficult to feel these bones at all. Somewhere between these extremes is a point at which point some fat has been stored to meet the heavy energy demands of (for example) lactation but it is not present in a gross excess which is costly to maintain.

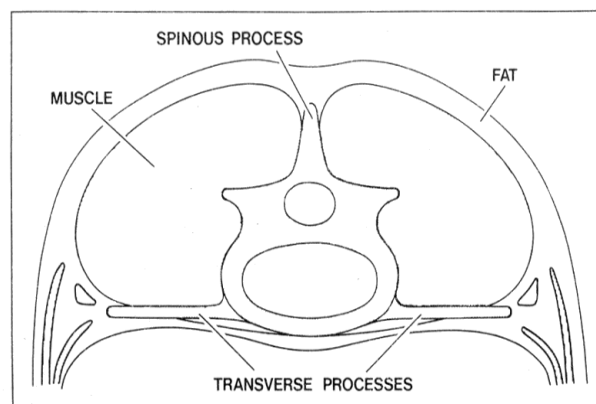

Figure E1 The spinous and transverse processes of the vertebrae in the loin area.

The vertebrae of the spine in the *loin* area (behind the last rib) have two projections which can be felt (fig. E1). The *spinous processes* of adjoining vertebrae form the bumpy topline of the back. The *transverse processes* are the horizontal bones coming out from either side of the backbone. It is the ease with which these processes can be felt that forms the basis for condition scoring.

In practice, condition scoring should be performed as follows (fig. E2):

- (1) Assess the prominence of the spinous processes by running the fingertips down the backbone.
- (2) Assess the prominence of the transverse processes by pushing the fingers down alongside the backbone.
- (3) Assess the amount of muscular and fatty tissue below the transverse processes by passing the fingers under the ends of these bones.
- (4) Assess the fullness of the eye muscle in the angle above and between the spinous and transverse processes.
- (5) Refer to figure E3, give each animal a score and record it so that comparisons can be made between animals and between scoring done at different times.



Figure E2 Manually assess the amount of muscular and fatty tissue around the transverse processes.

Condition scoring is a subjective and relative measure of a ewe's nutritional status, and will require some practice. What one producer calls a score of 3.5 will be another producer's 3. In addition, ewes should be scored *within breed and type*. For example, if you are accustomed to scoring Suffolk ewes and have established your scale of 1 to 5 on them, you will find that Finn ewes will rarely score over 3 and North Country Cheviot ewes will rarely score under 2. If you have a mixed flock, you must take these differences in consideration.

One condition score should be roughly equivalent to 10 kg (22 lb) or 15% of an animal's normal mature live weight. While learning the technique, it is useful to check apparent changes in condition by weighing.

The Uses of Condition Scoring

The discussion on nutrient requirements of ewes (pages 30-37) included liveweight and condition score targets at various stages of the reproductive cycle. The advantages of condition scoring in this context include the following:

- (1) the skill is easily learned and requires no equipment;
- (2) it overcomes differences in the sizes of animals which, of course, influence liveweight;
- (3) it can be used to assess the nutrient status of pregnant animals, where liveweight is difficult to interpret because of growth of the products of conception.

Condition scoring is used to assess the overall nutritional status of the flock allowing the producer to make management decisions about his feeding program. It can be a particular advantage to the large

flock where high-and low-scoring ewes can be separated and fed at different levels.

Score		Description	
1		Spine sharp, back muscle shallow,	Lean
2		Spine sharp, back muscle full, no fat	
3		Spine can be felt, back muscle full, some fat cover	Good Condition
4		Spine barely felt, muscle very full, thick fat cover	Fat
5		Spine impossible to feel, very thick fat cover, fat deposits over tail and rump	

Figure E3 Assign a condition score to each animal.

For example, if ewes are scored three weeks before breeding, those scoring below 3 can be flushed while those scoring above 3 can be fed to achieve a more modest increase in weight.

Condition scoring also allows the producer to identify individual animals in the flock which may be subject to chronic health problems. More often than not, the three to five year old ewe that scores significantly lower than the rest of the flock is a victim of Johne's disease, caseous lymphadenitis or chronic pneumonia.

ALLOCATING FEED RESOURCES

The earlier discussion on nutrient requirements should have made it clear that, in terms of efficient production some periods of the ewe's reproductive cycle demand higher nutrient intake than others. At the same time, it is often the case that a producer has more than a single types of forage available. For example, one hayfield which is due for renovation yielded almost straight grass hay which tested at 9.5% CP. The field which was renovated two years ago yielded a crop of hay having a significant content of clover. As a result, it tested at 14% CP.

Now, faced with the decision of which hay to feed to the ewes at what time, it should be obvious that the better quality hay should be fed when nutrient demand is high. It would make little sense to feed the better

quality hay in early pregnancy, leaving the poor hay for late pregnancy and lactation when protein supplement would be required to bolster its lower feeding value.

A similar situation may arise when lambs are weaned early in the pasture season, with ewes being bred as it ends. Productive ewes are generally in relatively poor condition at weaning (condition score 1.5-2.5) but the target for breeding is 3.5. They must, therefore, gain condition during this period. The tendency is to wean the ewes onto poor quality feed so that they maintain weight during the summer, and then rapidly flush them before breeding. In many cases, this is uneconomic. Since weight gain is costly, it is often better to allow the ewes to gain weight immediately after weaning when pasture is abundant, then maintain them later as pasture quality declines. It was pointed out earlier (p. 32) that maximum ovulations occur at a condition score of 3.5, whether or not the ewe is gaining weight or simply maintaining it at the time of breeding.

A third example of wise allocation of feed resources for lambs is discussed later under Creep Feeding (p. 53).

Feed Wasting

Figure E4 depicts a typical example of excess feed wastage. Although it is practically impossible to absolutely eliminate wastage of unchopped hay, some producers waste up to 30% of their total resource. Several factors influence waste:



Figure E4 Feed wasted is profit lost.

- (1) *Physical Form:* Since long hay is largely wasted when animals pull feed out of the feed bunk, chopping will solve this problem. Chopping also reduces the tendency for animals to select leaves in preference to stems.

However, chopping requires a significant investment in equipment which, for most sheep operations in B.C., would be difficult to justify.

- (2) *Feed Bunk Design:* The perfect, waste-free feed bunk for long hay has yet to be designed, although some are better than others. In particular those which allow the animals unlimited access to the feed with no impediment to pulling feed out are the most wasteful (fig. E5). Designs which reduce access by using closely spaced slats and prevent backing straight out by using diagonal or tombstone entries have been the most successful in preventing wastage (fig E6). Some consideration should also be given to reducing contamination of wool by feed. This can be achieved by allowing access to feed only in the lower part of the bunk.

Feeding on the ground is associated with extreme waste as well as fecal contamination leading to health problems. It can only be recommended when feed is placed on a clean area of snow where there is little risk of contamination

- (3) *Amount of Feed Offered:* Although *ad lib* feeding (p.37) is recommended for growing lambs, it is usually not necessary in feeding ewes. For example, in early pregnancy, ewes may consume up to 2.5 kg (5.5 lb) of hay offered *ad lib*, while their requirements demand an intake of only 1.5 kg (3.3 lb – 9% CP ; 55% TDN).

The situation depicted in figure E4 is often a result of overfeeding rather than a particularly poor feeder design. When ewes are offered more than they require, they tend to become increasingly selective. This is especially true when feeding alfalfa hay. Animals tend to eat the leaves in preference to the stems. When there is abundant feed offered, they will leave the stems behind resulting in significant waste. The solution is to feed an amount sufficient to satisfy the flock's requirements based upon knowledge of feed quality. This will serve to minimize selectivity and wastage except when the feed is very unpalatable or fibrous as is often the case with very mature, poor quality forages.

Finally, it should be realized that when feed intake is restricted (not fed *ad lib*) you will need to provide enough feed bunk space for all animals to eat at once (about 18" per head for ewes; 12" for lambs). In contrast, self-feeders require a provision of only 6" per head for ewes (3" for lambs). Nevertheless, the investment in increased feeder space is often abundantly returned in saved feed.

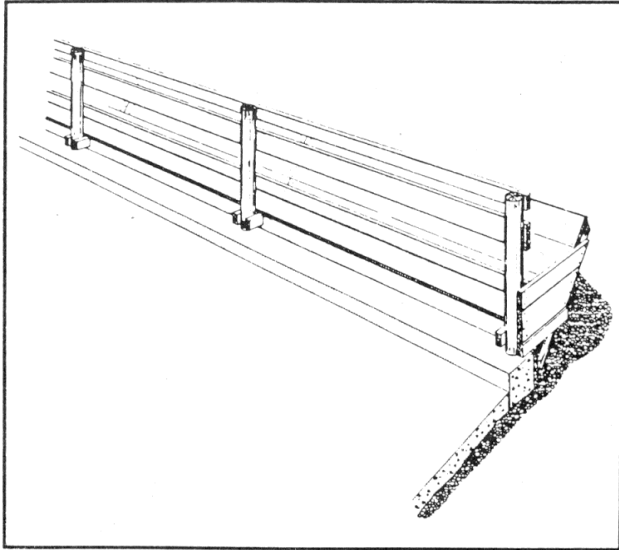

Figure E5 Hay feeders which allow liberal access to feed often promote waste

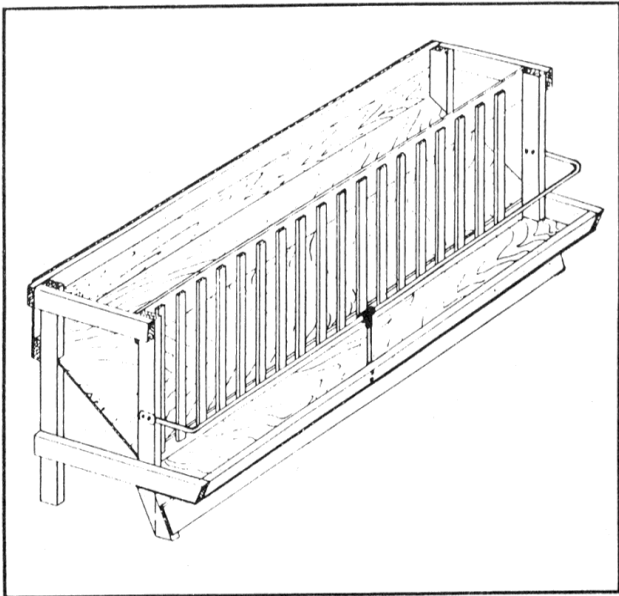

Figure E6 Feeders which restrict access to feed help to reduce waste.

Ration Changes

Digestion of feed in the ruminant is dependent upon a diverse population of bacteria and protozoa in the rumen and reticulum (p. 10). This population adapts to each specific ration and adaptation requires time while some microbial species expand in number and others decline. Bacteria which break down cellulose are not well adapted to starch digestion. Some

microbes produce mainly acetic acid from carbohydrates, others mainly propionic.

When rations are changed, time should be allowed for microbial adaptation. This is particularly true when grain is added to a forage ration. For example, when grain is introduced to ewes before lambing, it should be done in quarter kg (half lb) increments over the course of a week or more. This results in better feed utilization and prevents digestive disturbances. The latter is often seen when animals accidentally gain access to grain storage. Sudden consumption of large quantities of grain results in the production of high levels of lactic acid in the rumen, lowering the pH and destabilizing the entire fermentation process. Lactic acid enters the bloodstream causing acidosis and bloating (p. 13) may ensue. Recovery may be a prolonged process.

The use of urea in sheep rations also demands a period of adaptation. The proliferation of urease – producing bacteria (p.16) is a relatively slow process, and unless this is recognized, productivity will suffer because of the inability of the microbial population in the rumen to use urea for protein synthesis.

MINERAL FEEDING

A significant majority of B.C. feeds are deficient in one or several essential mineral elements. In particular, it is assumed without question that cobalt and iodine are universally in short supply, while selenium, copper (both absolutely and relative to molybdenum), zinc and phosphorus deficiencies often limit animal productivity.

There are three methods of providing mineral supplementation:

- (1) Incorporation in the ration. For example, lambs on full feed may have their mineral requirements added to a complete pelleted formulation. Alternatively, minerals may be incorporated into a supplement pellet designed for use with whole barley. When ewes are being fed grain, minerals may be added as a top dressing. These are ideal methods of assuring adequate intake, but are seldom used because of the expense of having complete rations formulated and the additional labour involved in mixing or top dressing on the farm.
- (2) Provision of mineral and salt free-choice in separate containers. This is probably the most common method of providing mineral

supplementation. However, it is often unsuccessful for one of several reasons:



Figure E7 A portable mineral feeder which is easy to keep clean.

- a. The mineral mix is unpalatable for reasons which are poorly understood; palatability and consumption of a mineral mix can vary from farm to farm.
- b. Mineral is often allowed to become fouled by manure because it is poorly placed.
- c. The mixture becomes wet, causing it to form into a hard mass and promoting oxidation reactions within the mix, decreasing its feeding value.

- (3) Provision of mineral in a mixture with salt. This usually solves the palatability and consumption problem because stock will always consume salt. However, fouling and moisture can still produce problems.

In the Lower Mainland, a complete mineral mix (including salt) has been made available which is designed to overcome the common deficiencies experienced in that area. Where such a custom mix is unavailable, the following recommendations have proven practical:

- (1) Construct a mineral feeder such as that illustrated in figure E7 which will:
 - a. be portable so that it can be moved from barn to pasture
 - b. be easy to keep clean
 - c. be covered to keep the mineral mix dry.
- (2) Purchase a *mineral mix*, preferably one designed specifically for sheep. It should have calcium and phosphorus levels in the 20% range and a copper level *not exceeding* 0.1% (see p. 24). Levels of the other minerals can vary quite widely

and should rarely be of primary concern but **READ THE LABEL.**

- (3) Purchase a *trace mineralized salt with selenium*. The salt level will be in the 95% range and the selenium should be at 25 ppm (or 25 grams/tonne or 25 mg/kg). Again, the copper level must not exceed 0.1% and again **READ THE LABEL.**
- (4) Mix thoroughly one part of the mineral mix with one part of the trace mineralized salt with selenium. The copper level will be 0.1% at most but should be at least 0.015% to prevent deficiency. Only mix as much as the sheep will consume in 5 to 10 days, then put out fresh mix. This will promote consumption and limit the amount of moisture uptake.
- (5) Provide fresh, clean water and locate the mineral feeder close by. Poor quality or insufficient water is definite discouragement to a good appetite.

A ewe should consume a minimum of 10 grams (0.4 ounces) per day of the 1:1 mixture. This means that 20 ewes should consume two kilograms (4.4 lb) in 10 days. If more than 20 grams (0.8 ounces)/ewe/day is consumed, decrease the proportion of mineral mix. Try, for example a 1:2 mixture of mineral:TM salt. If less than 10 grams (0.4 ounces)/ewe/day are consumed, increase the proportion of mineral.

These are blanket recommendations which will satisfy the flock's mineral requirements at all stages of production under most conditions of management and environment. They provide a wide margin of safety and, in doing so, will result in extra costs in many situations. For example, in formulating the lactating ration (example 1) in Section D, it was found that supplemental mineral containing Ca and P was not required. Again, feed testing and ration formulation based on nutrient analysis is the only way to assure good levels of productivity at minimum cost.

ADMINISTERING VITAMINS

As suggested earlier (p. 28) the only vitamins normally required by sheep are A, D, and E. Green, leafy forages provide adequate quantities but forages which have been weathered, heated or stored for prolonged periods are generally deficient.

Since all three of these "fat-soluble" vitamins are stored in body tissues, supplementation is required only periodically, the most common method being intra-muscular injection. This is required only every 8

to 10 weeks during the winter feeding period. Vitamin E may also be administered in combination with selenium either:

- (1) to ewes, two to three weeks before lambing begins, or;
- (2) to lambs, at birth, in an attempt to eliminate the occurrence of white muscle disease in the lambs.

Vitamins are also present in most mineral mixes but these should not be considered reliable sources. In the presence of minerals and moisture, the vitamins are rapidly oxidized. Since mineral mixes rapidly take up moisture in all but the driest parts of B.C., there can be little assurance that sufficient vitamins are obtained.

In some parts of the province, a vitamin ADE-Se premix is available which can be added to the ration or to the mineral being offered free-choice. In the latter case, care should be taken to prepare only as much premix-mineral as will be fed out in a week. Again, the mixture must be kept dry.

GRAZING MANAGEMENT

In many operations, grazed forage makes up a significant proportion of total feed intake. The efficiency with which pastures are utilized for animal production is a function of both the pasture itself and the management of the grazing animals. Figure E8 suggests relationships between stocking rates and both animal production per acre and productivity per animal. The main goal of grazing management is to increase the carrying capacity of the pasture (stocking rate) to the point where animal production per acre is maximized without significantly reducing productivity per animal.

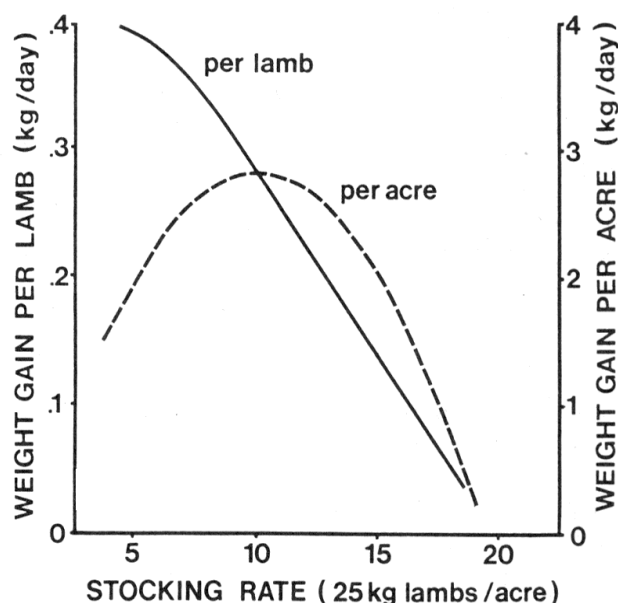

Figure E8 The effect of stocking rate on production per animal versus production per acre.

There are many factors which influence pasture productivity and grazing management decisions including:

- climate
- soil
- fertility
- forage species
- nutrient requirements of livestock
- predator control
- and many others.

It is beyond the scope of this publication to discuss these in detail.

STARTING NEWBORN LAMBS

Starvation is the most common cause of lamb mortality and the level of loss in a flock is strictly related to management. Unless lambs receive colostrum within two or three hours of birth, body energy reserves become critically depleted. Feeding management at this time should include tipping each ewe at lambing, checking the udder, removing wax plugs in the teat ends and assisting each lamb with its first meal. This should be followed by careful scrutiny of ewes and lambs two or three times a day and providing nursing assistance until one is confident that each lamb is off to a successful start.

Colostrum should be stored in frozen form in the event that a ewe has insufficient amount to meet the requirements of her lambs. This may be taken from a ewe that has lost her lambs or a ewe that has an

obvious excess. Colostrum may also be obtained from goats or cows for emergency use. The best colostrum is obtained from older animals since, having been exposed to more diseases, they will be producing a wider range of antibodies. In addition, the level of antibodies is highest in the first colostrum taken.

ORPHAN LAMBS

The decision to raise a lamb as an orphan should be made within 24 hours of birth since the success of training to a rubber nipple decreases with advancing age. An effective procedure is as follows:

- (1) Allow the designated orphan to remain with its natural mother until the evening of the day of birth making certain that an adequate amount of colostrum has been consumed.
- (2) Late in the evening of the day of birth, isolate the lamb into a small pen (e.g. a claiming pen) preferably with solid walls and, if necessary, a heat lamp.
- (3) Allow the lamb to fast overnight (no more than 8 hours) and in the morning begin training to a round-holed rubber nipple on a bottle containing milk or milk replacer at near body temperature.
- (4) Repeat the training process at two to three hour intervals, allowing the lamb to consume no more than 50-100ml (1.6-3.2 ounces) (depending on size) each time.
- (5) As acceptance of the nipple progresses, the temperature of the milk can be decreased at successive feedings. If the lamb is to continue to be hand-fed, the milk temperature should ultimately reach ambient temperature (10-20 degrees C). If being transferred to a bucket or otherwise self-fed, training should continue until the lamb will readily accept a bottle with a cross-cut nipple (p.11) containing milk at refrigerator temperature (2-6 degrees C).

In general, small amounts of milk consumed at frequent intervals will yield better results than large volumes fed infrequently. This simulates what occurs naturally when a lamb nurses its mother.

The management of orphan self-feeding is most successful when milk (or replacer) is kept cold (2-6 degrees C). When a nipple pail is used, a block of ice in a one litre ice cream pail will keep the temperature down. Low temperature milk causes the lambs to limit

their intake at each feeding. Warm milk is often consumed to the point of engorgement resulting in digestive disturbance. An additional aid in the prevention of digestive problems is the addition of 0.1% formalin to the milk. This reduces the growth of bacterial contaminants but should not be considered a substitute for good sanitation.

When raising orphan lambs, it is particularly valuable to encourage consumption of solid feed as soon as possible. Under intensive management, orphan lambs may be weaned as early as three weeks of age minimizing labour, milk replacer costs and the risks inherent in feeding liquid diets. However, this should not be attempted unless the lambs are vigorous, free of health problems and are consuming creep ration.

CREEP FEEDING

The practice of encouraging early consumption of solid feed serves to promote development of a functional rumen, increasing the ability of the lamb to utilize nutrients. The primary objective of creep feeding is to provide supplemental nutrients to the lambs during the nursing period to encourage rapid growth. Creep feeding in confinement has little relevance when lambing is timed to coincide with the availability of spring pasture. It is most useful when lambing precedes pasture availability by six weeks or more. In particular, in areas where the grazing season is short, confinement creep feeding can give lambs a significant "head start" on the pasture. Creep feeding on pasture will be dealt with below.

A common practice in B.C. is to lamb in late February or early March, feeding the ewes hay and grain until pasture becomes available. Lambs are either not offered creep or the management of the creep feeding program is such that consumption of creep ration by the lambs is minimal. Ewes and lambs are then put to pasture for the summer and at the end of the grazing season 25-50% of the lambs have not yet reached market size. They are either sold as feeders or the extra gain is put on with hay or grain.

This practice fails to take advantage of the high feed conversion efficiency (FCE) of which young lambs are capable. In fact, a pound of liveweight gain can be realized from less than two pounds of feed (FCE less than 2:1) in lambs six weeks to two months of age (table C11). On the other hand, lambs born in mid-March and coming off pasture in mid-September at a weight of 35-40 kg (77-88 lb) will likely need to consume about seven pounds of a 50:50 hay and grain ration for every pound of liveweight gain (FCE 7:1).

Clearly a dollar spent on grain in a creep ration is a better investment than the same dollar spent on grain in the fall. Similarly, grain is more efficiently fed to a young lamb than to its mother after two months of lactation.

Another advantage of creep feeding relates to early weaning. Lambs which are consuming more than a quarter kg (half lb) of creep ration can be safely weaned allowing placement in the feedlot or separate pasture use by ewes and lambs.

Design of the Creep Area

Figure E9 demonstrates several points concerning the design of a creep area. Panel A is the most common design used but it has two inherent faults:

- (1) Near the end of the creep feeding period, the oldest male lambs are often wider than those small ewes which have dropped in condition from heavy lactation. It may be impossible to space the pickets to allow these lambs to enter while excluding all of the ewes.
- (2) A heavy lamb making a rapid exit from the creep can often knock down one of the pickets, leaving a wide space for the ewes to enter. If there were a significant amount of creep ration in the feeder, grain overload could result.

Placement of a horizontal 1x4, to provide a 12 inch high opening with 10 inch spacing between pickets will improve panel A. The horizontal 1 x 4 will discourage ewes from entering the creep and is easily adjustable in height. If it is placed on the outside of the panel, it will become impossible for lambs to knock down single pickets.

Panel B is a good design but also invites some comment:

- (1) Placement of the three rollers is readily adjustable. While this may seem a strong feature of the design it is not necessary if a single, adjustable horizontal bar is placed across the opening.
- (2) Access to the creep is allowed only through the roller section rather than through the entire length as in Panel A. This is handy, as it allows you to easily catch lambs in the creep by simply blocking this small exit.

Panel C is a useful innovation which allows expansion of the creep area as the lamb crop grows. A similar

panel would replace Panel A. Plan on an allowance of 1.5-2.0 square feet of creep area per lamb.

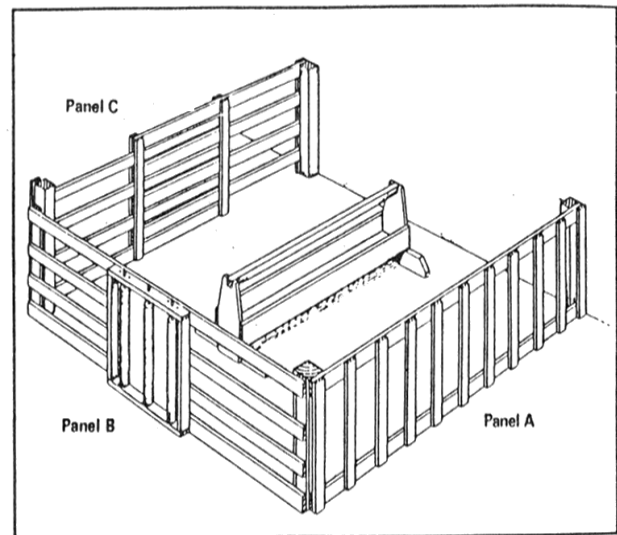

Figure E9 Components of lamb creep area.

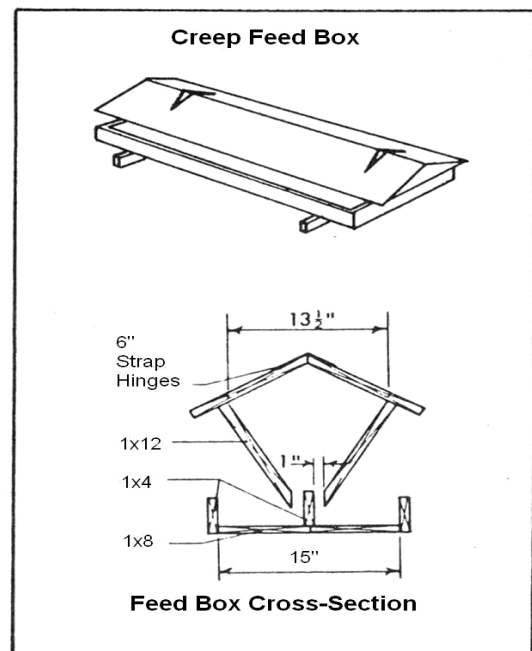

Figure E10 Creep self-feeder.

The design of the creep feeder itself should include the following:

- (1) *Limited access.* Lambs should not be able to put their feet into the feeder. Dirty feed is unattractive to them and fecal contamination spreads diseases such as coccidiosis.
- (2) *Sufficient capacity.* Although a small quantity of fresh feed twice daily should be put out in the first few weeks, a capacity of at least 1 pound of feed

per lamb should be planned for later in the creep feeding period.

The feeder shown in figure E9 is too open. Lambs will not hesitate to stand with their front feet in the feed. Placement of a horizontal board 6" above the throat board would improve the design. An alternative is shown in figure E10.

Fresh, clean water should be provided in the creep area once the oldest lamb is three weeks of age.

Lamb Psychology

Three factors dominate the behaviour of young lambs and a well-designed creep feeding program must recognize them:

- (1) *Attachment to the ewe.* A young lamb will not stray far from its mother. Once out of eyesight or earshot for any length of time, both ewe and lamb will attempt to re-establish contact. With this in mind, the creep should be placed as close as possible to the area where the ewes bed down. When in the creep, the lambs should be able to see the ewes. Unless these conditions are satisfied, lambs will not be encouraged to enter the creep area.
- (2) *Desire for comfort.* Once into the creep, lambs will be encouraged to stay if the area is well bedded, warm and bright. If the environment does not dictate the use of a heat lamp, a 40-watt bulb will make the area more attractive at night.
- (3) *Curiosity.* Lambs are inquisitive and will tend to explore their surroundings as long as it is not at the expense of their security. Curiosity will attract them into the creep and will encourage them to taste the feed offered. This behaviour can be reinforced by adding a small amount of fresh feed twice a day for the first few weeks.

Creep Ration

Many differences of opinion exist concerning ingredients and physical form of creep ration. However, the main factors to be considered are nutritional adequacy and palatability. The feeding program should be designed well in advance, and changes which will set back the lambs' progress should be avoided. The following management practices are recommended:

- (1) As early as possible after lambing begins, set up the creep and put out a very small quantity of

soybean meal. It is the most palatable feed commonly available and, although it is expensive, the lambs will consume an insignificant amount. Make sure the meal is always available and always fresh. Do not put out so much that it starts to accumulate in the bottom of the feeder. If it does, clean it out daily.

- (2) When the lambs are consuming 30-60 grams (1-2 ounces) per head per day, start adding a 2:1 mixture of whole barley and 32% protein supplement (containing no urea). In most cases, the lambs will begin to demonstrate a preference for the pellets and barley over a period of 7-10 days the proportion of soybean meal can be gradually decreased.
- (3) When the lambs reach a weight range of 25-35 pounds change the proportion of whole barley to pellets from 2:1 to 3:1.
- (4) When pasture becomes available, maintain access to the creep area and keep feed available. The lambs will gradually change themselves over to pasture consumption.
- (5) If you plan to raise the lambs in a feedlot situation, remove the ewes at weaning time so as not to disturb the feeding patterns of the lambs. Again, maintain access to the creep area and keep feed available. The importance of fresh, uncontaminated feed cannot be overemphasized. Feeders should never be empty nor should stale feed be allowed to accumulate.

Expected Results

If they can be attracted to the creep area, lambs will begin to nibble feed at two weeks of age. At six weeks of age they should be consuming close to a quarter kg (half lb) per day which is likely increasing their average daily gain by 0.1 kg (.22 lb).

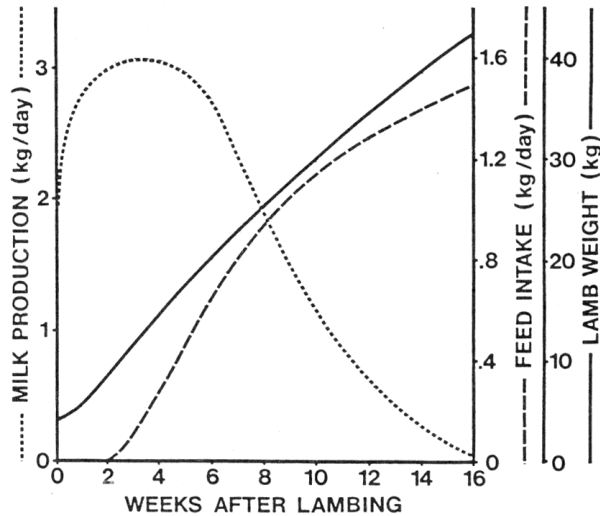

Figure E11 The relationship between the potential milk production of a ewe and the growth and dry feed intake of one of her twin lambs.

By two months of age, the total creep consumption will have reached 10kg (22 lb) per lamb resulting in a 5 kg (11 lb) "head-start" on pasture or the feedlot. Figure E11 relates consumption of solid feed to lamb growth and the ewe's milk production.

CREEP FEEDING ON PASTURE

When lambing coincides with the beginning of pasture growth in the spring, there is no advantage in encouraging the consumption of concentrates. In fact, early spring pasture is extremely high in nutrient content (table A2) and lambs tend to prefer this feed over any other. If the flock is confined at night, creep feeding of concentrates may be practised but usually with little success for two reasons:

- (1) concentrate intake is generally low because pasture intake is preferred; and
- (2) even when the concentrate is very palatable and a significant amount is consumed, this apparently does not supplement pasture consumption but simply substitutes for it (fig.E12).

If pastures have been allowed to decline in quality the above observations may not apply. Reduced pasture palatability may result in a preference for concentrate.

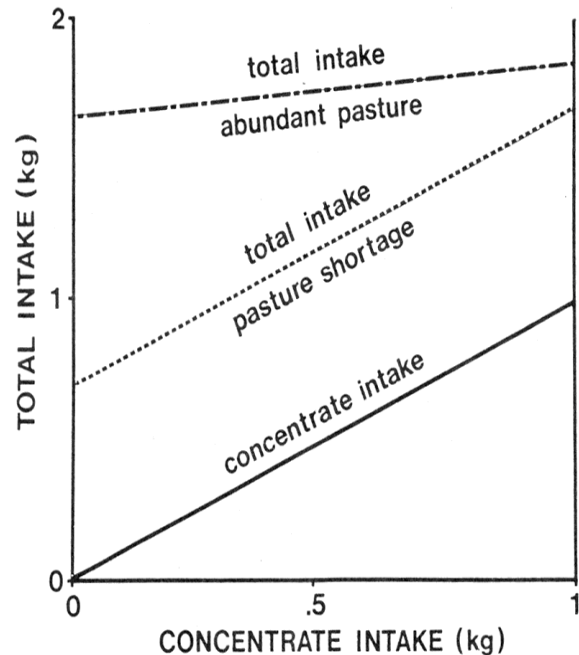

Figure E12 When pasture is abundant, concentrate intake replaces forage intake. Concentrate supplements forage intake when pasture is in short supply.

Forward Creep Grazing

When ewes and lambs are pastured together, lambs are subject to competition from their dams for the most palatable (and highest quality) forage. This tends to discourage forage consumption by the lambs and inhibits productivity. Forward creep grazing is a technique designed to overcome this competition.

When paddock, strip or rotational grazing strategies are used, lambs are allowed access to the next (forward) grazing area before the ewes (fig. E13). This is accomplished by setting up a creep panel between the "present" and the "forward" areas. The practice allows for the separate control of grazing pressures in the two areas. Grazing pressure is the "forward" area should always be light.

is the consumption of solid feed reflecting the development of the rumen. A lamb must be consuming a minimum of a quarter kg (half lb) per day before weaning. Under intensive management this may be achieved as early as three weeks of age. When feeding expensive milk replacers to orphan lambs, such very early weaning is an absolute necessity.

Researchers in Scotland have suggested that lambs weaned at about 6 weeks of age make the most efficient use of feed (table E1). These trails also suggested that weaning at 6 weeks was less stressful than weaning at 13 or 20 weeks, but only when the consumption of solid feed was adequate.

TABLE E1 The results of experiments in Scotland which showed that early weaning can yield high feed conversion efficiencies.

Weaning Age (weeks)	Feed Conversion Efficiency (kg feed/kg gain)
6	3.4
13	5.6
20	5.5

Weaning in Confinement

Successful early weaning in confinement is absolutely dependent upon a well managed creep feeding program. This involves offering a palatable, nutritious ration and clean, fresh water in a well lighted, comfortable creep, placed where the lambs will be attracted to it. Before the time comes to wean, the following points should be considered in order to reduce lamb stress and minimize the risk of mastitis in the ewe:

- (1) Lambs should have been vaccinated with 7-or 8-way clostridial vaccine.
- (2) A week before weaning, ewes should be changed from the high quality legume hay fed during lactation to a lower quality (but palatable) grass hay.
- (3) Four days before weaning, grain should be removed from the ewes' ration.
- (4) The day before weaning, ewes should be denied access to water and this should continue until the day after weaning.
- (5) At weaning, ewes should be removed from the lambs so that they are at least out of sight and,

preferably, out of earshot.

Weaning on Pasture

Early weaning is seldom an objective when the flock is on pasture and consequently the considerations outlined above are unnecessary. However, it is often desirable to wean in mid-summer when pasture quality begins to deteriorate. Lambs may be transferred to the feedlot for finishing or they may be finished on annual pastures such as oats, pasture rape or kale. In either case, the success of weaning will depend upon the degree of nutritional independence achieved by the lambs. This is a function of pasture management. If pastures have been maintained in the early vegetative (highly palatable) stage, at weaning, the lambs will be deriving most of their nutritional requirements through grazing. Milk demand will have decreased and weaning will present few complications.

FEEDING WEANED LAMBS

In the introduction to Section A, it was suggested that sheep and other ruminants are relatively inefficient in their conversion of feed to human food. This observation was made in the context of the animal production system as a whole. However, the potential feed conversion efficiency of the lamb itself rivals that of the feeder pig. Targets of 4 to 5 pounds of feed per pound of grain are well within reach for many of our genetically superior animals. Management practices for feeding lambs should be designed to take advantage of this potential. This is not meant to imply that such feed efficiencies can be realized in all management systems. On pasture, for example, lower conversion rates are offset by decreased feed costs. The ultimate measure of success is therefore the cost efficiency of feeding or the cost of feed per pound of gain.

Cost Efficient Gains

The process of lamb growth was described earlier. Lambs have the potential to grow very quickly when they are young, but as they age and the costs of maintenance increase, there is a decrease in this potential. Feed conversion efficiency (FCE) is highly correlated with average daily gain (ADG). In simple terms, rapid gains are efficient gains.

As growth progresses and FCE declines, the cost of the daily feed consumption approaches the market value of the daily gain. It is cost efficient to feed lambs to the point where the two values are equal. (fig. E14).

Of course, the actual weight at which this occurs depends upon:

- (1) *The individual animal.* Clearly, individuals within a crop of lambs grow at widely varying rates depending upon their genetic potential, their feed intake and their health status.
- (2) *The cost of gain.* As suggested above, when feed costs are low, slower gains can be tolerated. Nevertheless, given a particular feed, every effort should be made to maximize its conversion to gain. For example, it makes no sense to restrict the intake of feeder lambs (p. 38).

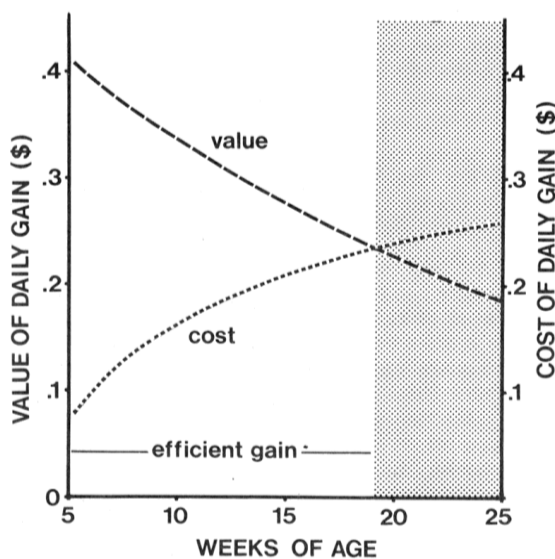

Figure E14 Lamb weight gains are efficient up to the point where the value of daily gain is equal to the cost of producing that gain.

When calculating the cost of gain, you should consider not only the cost of feed but other factors involved in extended feeding periods, such as veterinary cost, extra labour and facilities, interest on investment and risk of death loss.

- (3) *The market price of lamb.* This will vary with the market, the season, the market grade and the size of the carcass.

Some lambs have the ability to grow efficiently to heavy weights. In addition, many private customers will prefer the larger cuts from a heavier carcass. If the market is there, and gains are efficient, these lambs should be allowed to reach the heavier weights provided they do not become overfinished. Although

extra costs are incurred in allowing these animals to continue growing, additional profit will be realized as long as the gains are cost efficient.

Feedlot Lambs

Many producers prefer to raise lambs in confinement, practising creep feeding and early weaning with the pasture base being used exclusively for the ewes. There are several advantages to this approach:

- (1) Lambs can be grown out quickly on high energy rations, taking advantage of high feed conversion efficiencies and getting lambs to market before the seasonal decline in price (fig. C20).
- (2) The detrimental effects of gastrointestinal roundworms are minimized since these parasites require pasture to propagate.
- (3) The loss of lambs to predators is eliminated.
- (4) Pasture management requirements are reduced.

The disadvantages include the following:

- (1) Unit feed cost (\$/kg) are often higher since rations are usually based on supplemented grain.
- (2) Lambs in confinements are more subjected to the spread of diseases such as coccidiosis, pneumonia, sore-mouth and pinkeye.
- (3) Investment in facilities may be higher.

Feed Intake

Lambs fed for efficient gains should have *ad lib* access to feed. This implies that intake is limited only by the animals' appetite. In addition, any steps which might increase daily nutrient intake should be taken. These may include:

- (1) Increasing ration palatability by adding flavours to the feed (e.g. molasses);
- (2) Increasing the TDN content of the ration by using barley rather than oats;
- (3) Shearing lambs being fed during hot weather; and
- (4) Providing access to a source of clean, fresh water (p. 18). In hot weather, cold water promotes feed intake.

When feed intake is *restricted*, a greater proportion of the total nutrient intake is required for maintenance with a smaller contribution available for gain. The result is slower growth and reduced feed conversion efficiency (p. 36-37).

Processing Forages for Lambs

Grinding or milling hay can reduce waste and decrease the ability of the lambs to select, for example, alfalfa leaves in preference to stems. Processing reduces the digestibility of hay because its rate of passage through the rumen is increased, allowing less time for microbial degradation. At the same time, however, the rapid passage allows a greater availability of digestible nutrients. When fed in the ground form, particle size should be no smaller than 1-2 inches. More complete milling can produce rumen impaction and respiratory problems associated with dust.

Ground forages which have been pelleted (e.g., alfalfa pellets) have much the same feeding value as the same feeds simply ground. The same applies to cubes. Pelleting or cubing, however, may in some cases be accompanied by significant heating, resulting in heat damage to forage proteins.

Whole Grains in Lamb Rations

Experiments have been conducted at the University of British Columbia on the effect of feeding whole, rolled or pelleted grains to lambs. One result that has been consistent throughout these experiments has been better growth rate and feed efficiency when whole grain is fed compared to the same ration pelleted or fed as a mash.

Feeding whole grain offers the following advantages:

- (1) Feed intake may be increased by 25% while feed utilization remains the same for whole compared to pelleted grain.
- (2) Growth rate is 20 to 30% faster with whole grain.
- (3) Feed conversion efficiency is improved 5 to 10%.
- (4) Whole grains produce a firmer, more desirable fat finish on the carcass.
- (5) Whole grain does not cause damage to the lining of the rumen.

- (6) With whole grain there is less chance of lambs going "off feed" and of overeating disease or acidosis problems.

Much of the benefit of whole grains can be explained on the basis of better acceptance by the lambs and the higher level of feed intake. The lambs are very efficient at chewing the grains while ruminating which results in them being digested just as well as pre-ground grain. The physical form of the grain fibre remains intact in whole grain and results in slower fermentation in the rumen. Because of this the common problems associated with high grain feeding are greatly reduced and there is in fact no need to provide supplemental roughage when feeding whole grain.

In situations where forages are fed with grain there is also evidence that whole grain is preferable to pellets. Feed intake tends to be higher and the utilization of the forage is improved. The best choice of grain will vary with location, supply and price. In most situations, particularly in British Columbia, barley is probably the best grain for lamb feeding.

Based on these results, Dr. Malcolm Tait at the University of B.C. recommended the use of whole grains supplemented with a 32% protein pellet such as that described in figure C6.

Nursing lambs up to 15kg (33 lb) may be creep fed a mix of two parts barley to one part supplement. Initially, soya meal added to the mix may provide some additional incentive to early consumption. For lambs of 15-30 kg (33-66 lb) the mix is three parts barley to one part supplement and beyond 30 kg (66 lb) a 4:1 ration is used. These rations produce levels of about 18%, 16% and 14% protein respectively.

Feeding Behaviour

Lambs have the ability to be very selective in their feeding behaviour when they are given the opportunity. When grazing, they will select the youngest growth. If hay is fed, they will strip off the leaves and reject the stems. When whole grains and pelleted supplements are fed, care must be taken to ensure that both ingredients are consumed in proportion to the amounts offered. Lambs may select one ingredient over another on two criteria:

- (1) *Texture*. Pellets may be very hard and difficult to beak or they may be so soft that a significant proportion of the supplement becomes a mash at the bottom of the feeder.

- (2) *Flavour*. Some pellets contain molasses making them very palatable with the result that the lambs select them out of the grain mixture. On the other hand, pellets containing significant amounts of urea may be unpalatable with preference being shown towards the whole grain.

Ration sorting can be reduced by limiting the amount of feed in front of the lambs. When hand feeding (to appetite), it is more effective to put out small quantities of feed at frequent intervals than to put out large quantities infrequently. This may also have the effect of increasing intake. When self-feeders are used, the space through which feed is passed from bunk to the feed tray should be minimal (fig. E15). This results in a more continuous flow of mixed feed, with less opportunity for sorting or for feed to become stale.

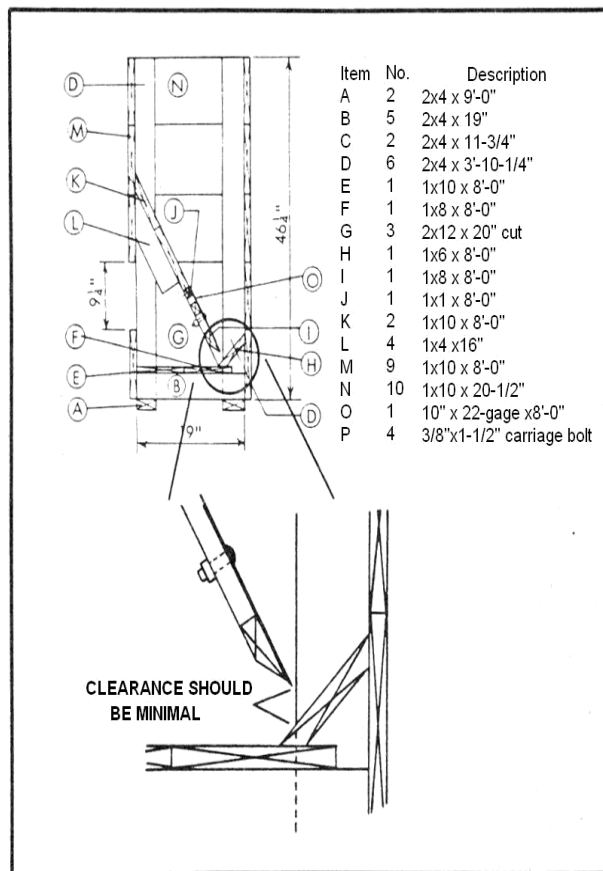

Figure E15 Reducing the space through which feed passes in a self-feeder minimizes sorting and feed wasting.

Slotted Floors

There are several advantages to the use of slotted floors for feeding lambs.

- (1) Space requirements are minimal, amounting to only 3-4 square feet per lamb.
- (2) Lambs are kept cool. This is a particular advantage in the summer months when high temperatures can reduce feed intake (p.21).
- (3) Lambs are kept dry. In the South Coastal region of B.C., lambs may be fed under a roof of minimal size and be kept up out of the mud.
- (4) The risk of fecal contamination leading to coccidiosis is reduced.
- (5) No bedding is required.

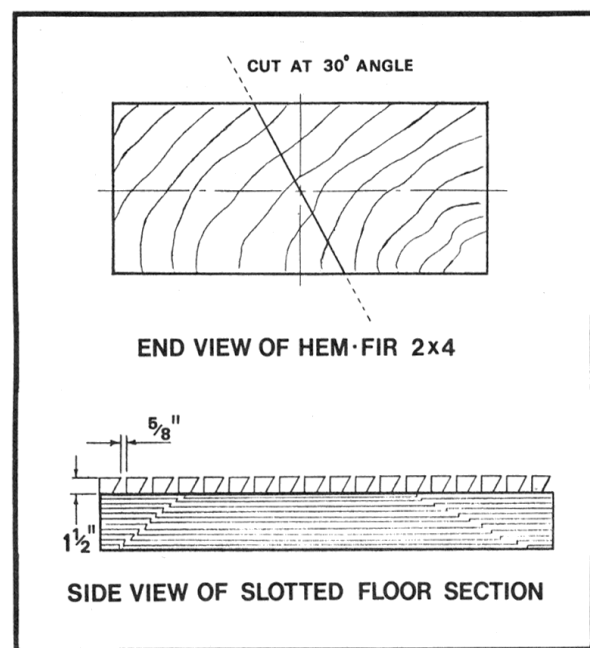

Figure E16 Slotted floors.

It should be mentioned that slotted floors are ineffective when more than five square feet per lamb is allowed. The high lamb densities are required to keep manure moving down through the slots. Feeding long hay on slotted floors often results in plugging of the slots.

When slotted floor sections are constructed of wood, the slats should be undercut as shown in figure E16. Straight-sided slots can easily become plugged.

Pasture Lambs

Young, leafy pasture provides a high energy level and sufficient protein, vitamins and minerals to permit growth rates in excess of 0.3kg (.66 lb)/day. On the

other hand, pasture which has entered the reproductive state is significantly lower in nutrient content (p.7) and may be capable of supporting little more than maintenance.

Pasture maturity also affects intake, with immature growth being far more palatable than reproductive growth. The effects of quality and palatability in combination drastically affect animal response.

Even when intensive pasture management is practised lambs should be allowed to graze under minimum pressure. High performance per animal should not be sacrificed for production per acre at this time (fig. E8) if maximum advantage is to be taken of the lambs' potential feed conversion efficiency.

Annual Pastures

Although few producers in BC have incorporated annual pastures into their management systems, they have significant potential for many. Their main use would be to supply forage in late summer and fall when many perennial pastures are declining in yield and quality. In some cases they can be used to supplement grazing of hay crop regrowth.

Crops suitable for annual pastures include fall rye, forage oats, pasture rape, kale and hybrid brassicas such as Tyfon. Most require 6-12 weeks to reach a stage where they can be efficiently utilized. Properly managed they can provide an abundance of nutrients for lambs approaching market size.

Shearing Lambs

As stated earlier, high summer temperatures can reduce feed intake. This effect is amplified when lambs have a significant wool covering. Heat which is produced in the digestive process cannot be dissipated because of the insulative effect of the fleece. Under these conditions, shearing may increase feed intake, daily gain and feed efficiency by as much as 10 to 15 percent. Alternatively, by using hair breeds one can avoid the practice of shearing.

Castrating Ram Lambs

Under good nutritional management, ram lambs grow 15-20% faster than ewe lambs with the performance of wethers being about midway between the other two. There is a significant advantage in terms of feed efficiency in leaving male lambs intact. In addition, ram lambs finish at heavier weights, often 5-10% higher than wethers. When a market for larger lambs

is available, there is a definite economic advantage to adding this extra weight.

However, early castration of male lambs also has its advantages. Unless lambs are marketed before they reach 5 months of age, intact males become a management problem. They must be separated from the female lambs, in particular, those to be selected as flock replacements. Even isolated, homosexual behaviour among intact males may reduce their interest in feed, resulting in decreasing gains.

In some instances, packers and abattoirs will apply penalties against male lambs on the basis of poor eating quality or increased skinning time. Although several research studies have examined these points, there is little evidence to suggest that they are valid reasons to penalize ram lambs.

An alternative to castration is the "short-scrotum technique" which results in the creation of cryptorchid rams. This technique involves pushing the testicles up into the abdomen and placing an elastrator ring high up on the empty scrotum (fig. E17). The scrotum drops off and the heat of the body within the abdomen prevents the formation of viable sperm. However, the testicles continue to produce male hormones resulting in no difference in feed efficiency in cryptorchids compared with intact ram. It should be noted that this procedure is subjected to periodic failure and even a single fertile male can undo a well-planned ewe lamb replacement program.

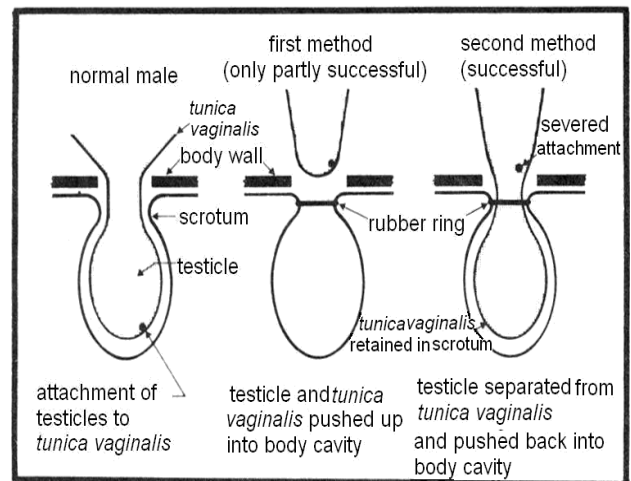

Figure E 17 The short scrotum method is an alternative to castration if it is properly performed.

FEED ADDITIVE AND GROWTH PROMOTERS

Consumers are asking for meat and meat products that are free of growth promoters and antibiotics. In

recent years there have been many debates over antimicrobial resistance and the use of feed additives and growth promoters in animal agriculture. In general these debates have not been positive for the marketing of meat. Arising out of concern for food safety is the development of the Canadian H.A.C.C.P - based On-Farm Food Safety Program for sheep and lambs. Sheep producers are required to keep medication and treatment records to meet the requirements of the program. The decision to use feed additives and growth promoters is expected to be a challenge for sheep producers as consumer awareness increases.

Very few feed additives or growth promoters are licensed in Canada for use in sheep. It is possible, however, to use most of the products available for cattle under veterinary prescription. It should be realized that these products are useful supplements to sound nutritional management but cannot be expected to have significant effects in under-nourished lambs.

Antibiotics

Chlortetracycline (Terramycin, Aureomycin) is licensed for the use in Canadian sheep rations at low levels. These levels are not sufficient to combat an existing infectious health problem. The antibiotics used in lamb rations produce increases in feed efficiency and average daily gain of 5-7% without affecting intake. Although the exact mechanism is unclear, it is thought that they affect the population distribution of rumen microbes and, thus, alter the yields of fermentation products. Antibiotic additives may also reduce digestive disturbances and decrease the incidence of enterotoxemia (overeating disease).

Coccidiostats

Although not registered for sheep in Canada, monensin (Rumensin®) has been used by a number of producers with good effect at levels of 11-22 mg/kg of total dry matter intake. Unfortunately, several cases of overdose have occurred as a result of improper mixing. At high levels, monensin is a potent muscle toxin, producing lesions similar to those of white muscle disease.

Monensin is actually a specific antibiotic and when included in rations for cattle the main effect is a change in the proportion of volatile fatty acids produced in the rumen (p.12). In sheep rations, the main effect is apparently a result of controlling a population of coccidia in the digestive tract. Coccidia are parasitic protozoa which cause decreased feed efficiency when present in significant numbers. Thus,

monensin results in increased feed efficiency in proportion to the initial level of coccidial infestation.

Bovatec® (lasalocid) which is licensed for sheep use in the U.S. but not in Canada has a mode of action similar to monensin. Amprolium which has long been used in poultry rations in Canada is another anti-coccidial (coccidiostat). It is now licensed for use in cattle rations but still not cleared for use with sheep.

TABLE E2 Criteria for establishing fat cover in market lambs.

Fat Class	Dock	Loin
1	Fat cover very thin. Individual bones very easy to detect	Spinous processes very prominent. Individual processes felt very easily. Transverse processes prominent. Very easy to feel between each process.
2	Fat cover thin. Individual bones detected easily with light pressure.	Spinous processes prominent. Each process is felt easily. Transverse processes - each process felt easily.
3	Fat cover moderate. Individual bones detected with light pressure.	Spinous and transverse processes - tips rounded. With light pressure individual bones felt as corrugations.
4	Fat cover quite thick. Individual bones detected only with firm pressure.	Spinous processes - tips of individual bones felt as corrugations with moderate pressure. Transverse processes - tips detected only with firm pressure.
5	Fat cover thick. Individual bones cannot be detected with firm pressure	Spinous and transverse processes - individual bones cannot be detected even with firm pressure.

MARKET LAMB APPRAISAL

It is important for the producer to be able to assess the market readiness of the lambs so that the maximum return can be realized. For this purpose a scale is absolutely essential. If a large number of lambs are marketed, convenient handling facilities are also a must.

In addition to measuring their actual weights, some method of assessing the lambs' degree of finish is required. A technique similar to that used in condition scoring ewes has been developed in the U.K. and is

equally applicable in B.C. This method relies upon feeling the back of the lamb in the loin area to assess the amount of muscle and fat covering the backbone. In addition, the dock, shoulder and chest are felt with the objective of judging how the carcass will grade after slaughter. Figure E18 identifies the areas to be assessed and table E2 outlines the criteria for establishing the degree of finish. The finish desired will depend on the market into which lambs are sold but classes 2-3 are generally considered ideal.



Along the breastbone (sternum).



Along the top of the backbone over the loin (spinous processes).



Along the spinous processes of the backbone over the shoulder.



Around the tips of the transverse processes of the backbone.



Around the tail root (dock).

Figure E18 Handling points for market lamb appraisal.

Appendix I Average Analyses of B.C. Feeds

The values given in the following table are not intended to substitute for the analysis of individual feeds. Looking at the crude protein (CP) values for forages in particular, it should be appreciated that wide variations are found between samples.

When analysis results are received from the lab, they should be compared with both values given in the table and results obtained from previous analyses of similar material from the same farm. Analysis levels which are markedly high or low should be questioned. Spurious values may be due to poor sampling or an error in analysis. In either case sampling and analysis

should be repeated so that one is confident in the results. It makes little sense to design a feeding program around analysis results which are questionable.

High and low values given in the table do not represent extremes. Analysis results obtained over all feeds in each category (e.g. TDN/alfalfa hays) were divided into three groups. High values given in the table represent the average analyses of samples in the top third.

One sixth of all samples will be above the value for each category. Likewise, a sixth of all values will be below the low value. This is illustrated in figure I1.

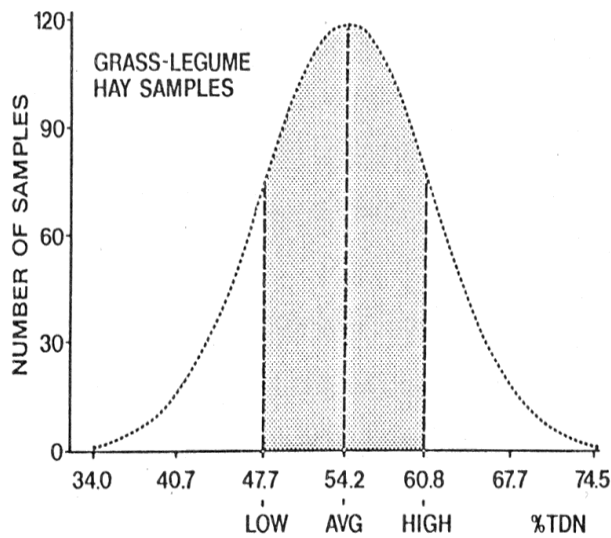

Figure I1 Two thirds of samples analyzed will lie between the low and high values given.

TABLE I1 A summary of feed analyses performed at the BC Soil and Feed Test Laboratory 1969-1984.

Feed Type		NUTRIENT											
		DM	TDN	CP	Ca	P	K	Mg	Fe	Mn	Zn	Cu	Mo
		%			ug/g								
Grass Hay.....	High	94.4	64.4	15.2	0.71	0.34	2.75	0.35	281	211	50	11.4	6.1
	Average	88.4	55.9	10.3	0.47	0.23	1.81	0.20	147	113	26	7.0	3.5
	Low	81.9	47.4	5.4	0.23	0.12	0.87	0.15	13	15	2	2.6	< 1.0
Grass Legume Hay.....	High	95.0	60.8	16.1	1.43	0.29	2.94	0.39	247	108	41	14.2	5.6
	Average	87.3	54.2	11.8	0.87	0.22	2.06	0.24	133	59	24	8.7	3.1
	Low	79.6	47.7	7.5	0.31	0.15	1.18	0.09	19	9	7	3.2	< 1.0
Alfalfa Hay.....	High	95.9	64.9	19.4	1.93	0.37	3.21	0.43	446	58	38	15.1	4.3
	Average	88.7	57.0	16.4	1.33	0.27	2.47	0.28	251	35	23	9.7	2.6
	Low	81.5	49.2	13.4	0.73	0.17	1.73	0.13	56	13	9	4.2	< 1.0
Cereal Hay.....	High	95.2	64.9	14.0	0.57	0.37	3.04	0.33	360	100	40	14.6	4.1
	Average	86.4	60.9	9.3	0.37	0.26	1.95	0.18	194	55	26	7.8	2.4
	Low	77.6	56.9	4.6	0.17	0.17	0.86	0.03	28	10	12	1.0	< 1.0
Barley Grain.....	High	92.6	84.6	13.2	0.19	0.46	0.63	0.17	19	36	59	17.8	2.3
	Average	88.6	81.4	11.2	0.11	0.38	0.53	0.15	119	22	45	11.0	1.7
	Low	84.5	78.2	9.3	0.03	0.30	0.43	0.13	219	8	32	4.2	< 1.0
Oats Grain.....	High	90.8	80.6	12.8	0.18	0.40	0.78	0.15	121	70	45	14.6	3.8
	Average	87.7	76.9	10.9	0.10	0.34	0.70	0.13	79	48	37	7.8	2.4
	Low	84.5	73.2	9.0	0.02	0.28	0.62	0.11	38	26	28	1.0	< 1.0
Grass Silage.....	High	47.5	59.7	16.0	0.82	0.60	3.43	0.42	570	198	55	15.8	4.4
	Average	35.1	53.3	12.6	0.57	0.40	2.47	0.30	352	124	35	9.1	2.6
	Low	22.7	47.0	9.3	0.32	0.20	1.51	0.18	134	50	15	2.4	0.8
Grass Legume Silage.....	High	46.6	58.1	18.7	1.33	0.34	2.98	0.38	509	122	51	13.9	5.6
	Average	34.4	53.3	15.5	0.93	0.26	2.28	0.25	287	76	31	8.7	3.2
	Low	22.2	48.5	12.2	0.53	0.18	1.58	0.12	65	30	11	3.5	0.7
Corn Silage.....	High	37.6	71.8	10.8	0.60	0.30	1.63	0.32	360	80	47	11.2	2.4
	Average	29.6	63.9	8.8	0.36	0.24	1.29	0.20	213	47	29	7.0	1.7
	Low	21.6	56.0	6.8	0.12	0.18	0.95	0.08	66	14	11	2.8	1.0
Cereal Silage.....	High	53.4	77.9	11.6	0.60	0.40	2.38	0.27	498	113	48	13.1	3.9
	Average	38.2	63.4	9.1	0.39	0.28	1.61	0.19	283	66	32	7.1	2.5
	Low	22.9	48.9	6.7	0.18	0.16	0.84	0.11	68	18	16	1.1	1.1

NUTRIENT REQUIREMENTS OF SHEEP TABLES

Energy and protein requirements of sheep were projected as described earlier in the Energy and Protein sections (Chapters 4 and 5). Energy requirements are influenced by age and stage of maturity in the CNCPS-S method, in addition to effects of BW and ADG (Cannas et al., 2004). Because the efficiency of energy utilization for gain in CNCPS-S varies with diet metabolizability, values are given for three dietary ME concentrations: 1.91, 2.39, and 2.87 Mcal/kg DM (i.e., 8, 10, and 12 MJ/kg DM, respectively). The visceral organ adjustment (VO) of the ME requirement for maintenance of CNCPS-S, which is based on ME intake, was included. VO was determined from and added to ME intake estimated without the adjustment. Listed DM intakes are needed to supply required energy from the indicated energy concentrations of the diets. Selections were made from the three example diets based on an expected range of intake on a percent of body weight. In some instances, selections of other diets may be more appropriate. The protein requirement for fiber growth was based on the method of SCA (1990), assuming a ratio of standard fleece weight (greasy fiber produced by a mature sheep per year) to mature BW at BCS of 3.0 (scale of 0 to 5) of 0.1, along with an adjustment for age when less than 2 years. The metabolic fecal protein requirement, which is a component of the maintenance need, was based on the estimate of DM intake required to supply needed energy for a given BW to achieve the specified level of production. Because the relationship between MP and CP requirements varies with the nature of the diet, the aforementioned conversion of CP to MP of NRC (2000) was applied for diets with rumen undegraded intake (UIP) concentrations of 20, 40, and 60 percent of total CP. The requirement for DIP is given as well. It is important to note that in some instances the DIP needed is greater than required amounts of CP. For example, an 80 kg ewe (at maintenance) consuming a diet with an ME concentration of 1.91 Mcal/kg would require 98 g of CP with diet having a UIP concentration of 20 percent of CP. Under these conditions, DIP intake is 78 g (i.e., 98×80 percent DIP), but the esti-

ated DIP requirement is 90. Hence, to satisfy the DIP requirement, intake of CP with this diet would be 112 g, with a corresponding greater dietary CP requirement on a concentration basis (i.e., 8.7 vs. 7.5 percent). Also, the DIP requirements often exceed the estimates of MP requirements and are partially supplied by recycled nitrogen. Because BCS is an input to determine the energy concentration in tissue being accreted or mobilized in mature sheep in the CNCPS-S method, for mature animals and yearlings a concentration of 5.7 Mcal/kg was assumed. Assumptions used to derive the recommended requirements presented in Tables 15-1 and 15-2 are given below.

Requirements for mature ewes were determined assuming an age of 3 years and a 100 percent stage of maturity. Requirements for early, mid-, and late lactation are given with assumptions of BW change. Because CNCPS-S assumes that efficiencies of energy utilization for maintenance and lactation are the same, requirements for ME and TDN do not differ among dietary ME concentrations with negative and 0 ADG (Table 15-1). Requirements for all classes in which weight gain is attached (other than recovery weight gain) are presented in Table 15-2. These classes include growing lambs and yearlings and yearling ewes at maintenance (plus growth), gestation, and lactation. Requirements are presented for "Farm" and "Range" yearlings for common production systems and practices, which include typical ages and stages of maturity in the various stages of production. An age of 3 years and stage of maturity of 100 percent were assumed for rams. Energy and protein requirements in the breeding period were increased by 10 percent of maintenance energy and protein needs for mature ewes, yearlings, and rams.

Pregnancy requirements are presented for early and late gestation, with input of day 105 and 133, respectively. Yearlings were assumed to be growing during gestation. Live weight gain values given for gestating animals are for both pregnancy and nonpregnancy tissues of yearlings. The maintenance requirement for nonpregnancy tissues should, how-

NUTRIENT REQUIREMENTS OF SHEEP TABLES

ever, be based on weight of nonpregnancy tissues alone or weight of the animal before days 80–90 of pregnancy.

For growing/finishing sheep, values are presented for two ages, 4 and 8 months, which affect the maintenance energy requirement. Stage of maturity, affecting the energy concentration in tissue being gained, is 30 and 60 percent for 4-month-old lambs and 40 and 80 percent for 8-month-old lambs. These combinations should provide values applicable to many production practices. For example, a 4-month-old wether with a BW 30 percent of that when mature at a BCS of 3.0 (5-point scale) is at an early stage of maturity and possibly of a late-maturing breed; hence, a considerable portion of tissue being gained would be lean. On the other extreme, a wether 8 months of age with a BW 80 percent of that when mature would be at a late stage of maturity and most likely of an early maturing breed accreting considerable fat. In addition to values for wether and ewe lambs, val-

ues are presented for ram lambs, which differ because of a greater energy requirement for maintenance.

Tables 15-1 and 15-2 include estimates of requirements of Ca and P and vitamins A and E. Requirements for the remaining essential minerals are included in Table 15-3. Details of the requirements of minerals and vitamins are discussed in Chapters 7 and 8, respectively.

REFERENCES

- Cannas, A., L. O. Tedeschi, D. G. Fox, A. N. Pell, and P. J. Van Soest. 2004. A mechanistic model for predicting the nutrient requirements and feed biological values for sheep. *J. Anim. Sci.* 82:149–169.
- NRC. 2000. *Nutrient Requirements of Beef Cattle (Update 2000)*. Washington, DC: National Academy Press.
- SCA (Standing Committee on Agriculture). 1990. *Feeding Standards for Australian Livestock. Ruminants*. East Melbourne, Australia: CSIRO Publications.

TABLE 15-1 Nutrient Requirements of Sheep (mature ewes and rams and yearlings maintenance and lactation)

Class/Age/Other	Body Weight ^a kg	Birth Weight or Milk Yield ^b kg	Body Weight Gain ^c g/d	Energy Concentration in Diet ^d kcal/kg	Daily Dry Matter Intake ^e kg	Energy Requirements/		Protein Requirements ^f				Mineral Requirements ^g		Vitamin Requirements ^h			
						TDN kg/d	ME Mcal/d	CP @20% UIP g/d	CP @40% UIP g/d	CP @60% UIP g/d	MP g/d	DIP g/d	Ca g/d	P g/d	A RE/d	E IU/d	
																	kg/d
Mature Ewes																	
Maintenance only																	
40	0	0	0	1.91	0.77	1.93	0.41	1.48	59	56	54	40	53	1.8	1.3	1,256	212
60	0	0	0	1.91	0.91	1.83	0.49	1.75	69	66	63	47	63	2.0	1.5	1,570	265
70	0	0	0	1.91	1.05	1.75	0.56	2.01	79	76	72	53	72	2.2	1.8	1,884	318
80	0	0	0	1.91	1.18	1.68	0.62	2.25	89	85	81	60	81	2.4	2.0	2,198	371
90	0	0	0	1.91	1.30	1.63	0.69	2.49	98	94	90	66	90	2.6	2.2	2,512	424
100	0	0	0	1.91	1.42	1.58	0.75	2.72	107	103	98	72	98	2.8	2.5	2,826	477
120	0	0	0	1.91	1.54	1.54	0.82	2.94	116	111	106	78	106	3.0	2.7	3,140	530
140	0	0	0	1.91	1.76	1.47	0.94	3.37	134	128	123	90	122	3.3	3.1	3,768	636
140	0	0	0	1.91	1.98	1.41	1.05	3.79	151	145	138	102	136	3.7	3.5	4,396	742
Breeding																	
40	20	0	20	1.91	0.85	2.13	0.45	1.63	69	66	63	46	59	2.1	1.5	1,256	212
50	23	0	23	1.91	1.01	2.01	0.53	1.92	81	77	74	55	69	2.4	1.8	1,570	265
60	26	0	26	1.91	1.15	1.92	0.61	2.21	93	89	85	62	80	2.6	2.1	1,884	318
70	29	0	29	1.91	1.30	1.85	0.69	2.48	104	99	95	70	89	2.9	2.4	2,198	371
80	32	0	32	1.91	1.43	1.79	0.76	2.74	115	110	105	77	99	3.1	2.7	2,512	424
90	35	0	35	1.91	1.56	1.74	0.83	2.99	126	120	115	85	108	3.4	2.9	2,826	477
100	38	0	38	1.91	1.69	1.69	0.90	3.24	137	130	125	92	117	3.6	3.2	3,140	530
120	44	0	44	1.91	1.94	1.62	1.03	3.71	157	150	144	106	134	4.0	3.7	3,768	636
140	50	0	50	1.91	2.18	1.56	1.15	4.16	177	169	162	119	150	4.5	4.2	4,396	742
Early gestation (Single lamb; BW = 3.9 to 7.5 kg)																	
40	3.9	18	18	1.91	0.99	2.47	0.52	1.89	82	79	75	55	68	3.4	2.4	1,256	212
50	4.4	21	21	1.91	1.16	2.32	0.61	2.21	96	91	87	64	80	3.8	2.8	1,570	265
60	4.8	24	24	1.91	1.31	2.19	0.70	2.51	108	103	99	73	91	4.2	3.2	1,884	318
70	5.2	27	27	1.91	1.46	2.09	0.78	2.80	120	114	110	81	101	4.5	3.5	2,198	371
80	5.6	30	30	1.91	1.61	2.01	0.85	3.08	132	126	120	89	111	4.9	3.9	2,512	424
90	6.0	33	33	1.91	1.75	1.95	0.93	3.35	143	137	131	96	121	5.2	4.2	2,826	477
100	6.3	35	35	1.91	1.89	1.89	1.00	3.61	154	147	141	104	130	5.5	4.5	3,140	530
120	7.0	41	41	1.91	2.15	1.79	1.14	4.11	176	168	161	118	148	6.1	5.1	3,768	636
140	7.5	46	46	1.91	2.39	1.71	1.27	4.58	196	187	179	132	165	6.7	5.7	4,396	742
Early gestation (Twin lambs; BW = 3.4 to 6.6 kg)																	
40	3.4	30	30	1.91	1.15	2.87	0.61	2.20	100	95	91	67	79	4.8	3.2	1,256	212
50	3.8	35	35	1.91	1.31	2.62	0.70	2.51	112	107	103	76	90	5.4	3.7	1,570	265
60	4.2	40	40	1.91	1.51	2.52	0.80	2.89	129	124	118	87	104	5.9	4.2	1,884	318
70	4.6	45	45	1.91	1.69	2.41	0.89	3.22	144	137	131	97	116	6.5	4.6	2,198	371
80	4.9	50	50	1.91	1.84	2.30	0.98	3.52	157	150	143	105	127	7.0	5.1	2,512	424
90	5.2	55	55	1.91	2.00	2.22	1.06	3.82	170	162	155	114	138	7.4	5.5	2,826	477
100	5.5	59	59	1.91	2.15	2.15	1.14	4.10	182	174	167	123	148	7.9	5.9	3,140	530
120	6.1	68	68	1.91	2.44	2.03	1.29	4.66	207	198	189	139	168	8.7	6.6	3,768	636
140	6.6	76	76	1.91	2.71	1.94	1.44	5.18	231	220	211	155	187	9.5	7.3	4,396	742

Early gestation (Three lambs; BW = 2.9 to 5.7 kg)

40	2.9	39	2.39	1.00	2.51	0.67	2.40	103	98	94	69	86	5.4	3.3	1,256	212
50	3.3	46	1.91	1.46	2.92	0.77	2.79	129	123	117	86	101	6.5	4.4	1,570	265
60	3.6	52	1.91	1.65	2.74	0.87	3.15	144	137	131	97	113	7.1	4.9	1,884	318
70	3.9	59	1.91	1.82	2.61	0.97	3.49	159	152	145	107	126	7.8	5.4	2,198	371
80	4.2	65	1.91	2.00	2.50	1.06	3.82	174	166	159	117	138	8.3	5.9	2,512	424
90	4.5	71	1.91	2.17	2.41	1.15	4.14	188	180	172	127	149	8.9	6.3	2,826	477
100	4.7	77	1.91	2.32	2.32	1.23	4.43	201	192	183	135	160	9.4	6.7	3,140	530
120	5.2	88	1.91	2.63	2.19	1.39	5.02	228	217	208	153	181	10.4	7.6	3,768	636
140	5.7	99	1.91	2.92	2.09	1.55	5.59	254	242	232	171	202	11.4	8.4	4,396	742

Late gestation (Single lamb; BW = 3.9 to 7.5 kg)

40	3.9	71	2.39	1.00	2.49	0.66	2.38	101	96	92	68	86	4.3	2.6	1,820	224
50	4.4	84	1.91	1.45	2.89	0.77	2.76	126	120	115	85	100	5.1	3.5	2,275	280
60	4.8	97	1.91	1.63	2.71	0.86	3.11	141	134	129	95	112	5.7	4.0	2,730	336
70	5.2	109	1.91	1.80	2.58	0.96	3.45	156	149	142	105	124	6.1	4.4	3,185	392
80	5.6	120	1.91	1.98	2.47	1.05	3.78	170	163	155	114	136	6.6	4.8	3,640	448
90	6.0	131	1.91	2.15	2.38	1.14	4.10	185	176	169	124	148	7.1	5.2	4,095	504
100	6.3	142	1.91	2.30	2.30	1.22	4.40	198	189	180	133	158	7.5	5.5	4,550	560
120	7.0	163	1.91	2.61	2.17	1.38	4.99	224	214	205	151	180	8.3	6.3	5,460	672
140	7.5	183	1.91	2.89	2.06	1.53	5.52	248	237	226	167	199	9.0	6.9	6,370	784

Late gestation (Twin lambs; BW = 3.4 to 6.6 kg)

40	3.4	119	2.87	1.06	2.66	0.85	3.05	128	123	117	86	110	6.3	3.4	1,820	224
50	3.8	141	2.39	1.47	2.93	0.97	3.50	155	148	141	104	126	7.3	4.3	2,275	280
60	4.2	161	2.39	1.65	2.75	1.09	3.94	173	165	158	116	142	8.1	4.8	2,730	336
70	4.6	181	2.39	1.83	2.61	1.21	4.37	192	183	175	129	158	8.8	5.3	3,185	392
80	4.9	200	2.39	1.99	2.48	1.32	4.75	208	198	189	139	171	9.4	5.8	3,640	448
90	5.2	218	1.91	2.68	2.97	1.42	5.12	241	230	220	162	185	10.7	7.2	4,095	504
100	5.5	236	1.91	2.87	2.87	1.52	5.48	258	246	236	173	198	11.3	7.7	4,550	560
120	6.1	271	1.91	3.24	2.70	1.72	6.19	291	278	266	196	223	12.5	8.6	5,460	672
140	6.6	304	1.91	3.57	2.55	1.89	6.83	321	307	293	216	246	13.6	9.5	6,370	784

Late gestation (Three or more lambs; BW = 2.9 to 5.7 kg)

40	2.9	155	2.87	1.22	3.04	0.97	3.49	150	144	137	101	126	7.7	4.1	1,820	224
50	3.3	183	2.87	1.41	2.81	1.12	4.03	173	165	158	116	145	8.7	4.7	2,275	280
60	3.6	210	2.87	1.57	2.61	1.25	4.50	192	183	175	129	162	9.5	5.2	2,730	336
70	3.9	235	2.39	2.07	2.96	1.37	4.95	222	212	203	149	178	10.8	6.4	3,185	392
80	4.2	260	2.39	2.26	2.82	1.50	5.40	241	230	220	162	195	11.6	6.9	3,640	448
90	4.5	284	2.39	2.44	2.71	1.62	5.83	261	249	238	175	210	12.3	7.4	4,095	504
100	4.7	307	2.39	2.59	2.59	1.72	6.20	276	263	252	185	223	13.0	7.9	4,550	560
120	5.2	352	2.39	2.92	2.43	1.93	6.97	310	296	283	209	251	14.4	8.8	5,460	672
140	5.7	396	1.91	4.04	2.89	2.14	7.73	371	355	339	250	279	16.7	11.2	6,370	784

Early lactation (Single lamb; milk yield = 0.71 to 1.32 kg/d)

40	0.71	-14	2.39	1.09	2.73	0.72	2.61	156	149	143	105	94	4.1	3.4	1,820	224
50	0.79	-16	2.39	1.26	2.51	0.83	3.00	177	169	161	119	108	4.6	3.9	2,275	280
60	0.87	-17	1.91	1.77	2.96	0.94	3.39	210	200	191	141	122	5.4	5.0	2,730	336
70	0.94	-19	1.91	1.96	2.80	1.04	3.75	229	219	209	154	135	5.9	5.5	3,185	392
80	1.00	-20	1.91	2.13	2.67	1.13	4.08	248	237	226	167	147	6.3	5.9	3,640	448

TABLE 15-1 continued

Class/Age/Other	Body Weight ^a kg	Birth Weight or Milk Yield ^b kg	Body Weight Gain ^c g/d	Energy Concentration in Diet ^d kcal/kg	Daily Dry Matter Intake ^e kg	Energy Requirements/ TDN	Protein Requirements ^f			Mineral Requirements ^h		Vitamin Requirements ⁱ				
							CP @20% UIP g/d	CP @40% UIP g/d	CP @60% UIP g/d	MP g/d	DIP g/d	Ca g/d	P g/d	A RE/d	E IU/d	
Early lactation (Twin lambs; milk yield = 1.18 to 2.21 kg/d)																
90	1.06	-21	1.91	2.30	2.56	1.22	4.41	266	254	243	179	159	6.7	6.4	4,095	504
100	1.12	-22	1.91	2.47	2.47	1.31	4.73	284	272	260	191	170	7.1	6.8	4,550	560
120	1.22	-24	1.91	2.78	2.32	1.47	5.32	317	303	290	213	192	7.8	7.6	5,460	672
140	1.32	-26	1.91	3.08	2.20	1.63	5.89	349	333	319	235	212	8.5	8.4	6,370	784
40	1.18	-24	2.39	1.40	3.51	0.93	3.35	224	213	204	150	121	6.0	5.0	2,140	224
50	1.32	-26	2.39	1.61	3.22	1.07	3.85	254	242	231	170	139	6.7	5.7	2,675	280
60	1.45	-29	2.39	1.80	3.01	1.20	4.31	281	268	257	189	155	7.3	6.3	3,210	336
70	1.56	-31	2.39	1.98	2.83	1.31	4.73	306	292	279	205	171	7.9	6.9	3,745	392
80	1.67	-33	2.39	2.15	2.69	1.43	5.15	330	315	302	222	186	8.5	7.4	4,280	448
90	1.77	-35	2.39	2.32	2.57	1.54	5.54	353	337	322	237	200	9.0	8.0	4,815	504
100	1.87	-37	2.39	2.48	2.48	1.64	5.92	376	359	343	253	213	9.5	8.5	5,350	560
120	2.05	-41	1.91	3.47	2.89	1.84	6.63	441	421	403	296	239	11.3	10.7	6,420	672
140	2.21	-44	1.91	3.82	2.73	2.03	7.30	483	461	441	324	263	12.3	11.7	7,490	784
Early lactation (Three or more lambs; milk yield = 1.53 to 2.87 kg/d)																
40	1.53	-31	2.87	1.36	3.41	1.08	3.91	265	253	242	178	141	7.1	5.7	2,140	224
50	1.72	-34	2.39	1.88	3.76	1.24	4.49	311	297	284	209	162	8.3	7.0	2,675	280
60	1.88	-38	2.39	2.09	3.48	1.38	4.99	343	327	313	230	180	9.1	7.8	3,210	336
70	2.03	-41	2.39	2.29	3.27	1.52	5.48	373	356	341	251	197	9.8	8.5	3,745	392
80	2.17	-43	1.91	3.11	3.89	1.65	5.94	423	404	387	285	214	11.3	10.3	4,280	448
90	2.30	-46	1.91	3.34	3.71	1.77	6.38	452	431	413	304	230	12.0	11.0	4,815	504
100	2.43	-49	1.91	3.56	3.56	1.89	6.80	480	458	438	323	245	12.7	11.7	5,350	560
120	2.66	-53	1.91	3.98	3.32	2.11	7.61	533	508	486	358	274	13.9	13.0	6,420	672
140	2.87	-57	1.91	4.37	3.12	2.32	8.36	581	555	531	391	301	15.1	14.1	7,490	784
Early lactation (Parlor production only; milk yield = 2.37 to 3.97 kg/d)																
50	2.37	-47	2.87	1.93	3.85	1.53	5.52	392	374	358	263	199	10.4	8.5	2,675	280
60	2.60	-52	2.87	2.14	3.57	1.70	6.14	432	413	395	291	221	11.4	9.4	3,210	336
70	2.81	-56	2.87	2.34	3.35	1.86	6.72	470	449	429	316	242	12.4	10.3	3,745	392
80	3.00	-60	2.39	3.04	3.80	2.01	7.26	522	498	476	351	262	13.8	12.0	4,280	448
90	3.18	-64	2.39	3.25	3.61	2.16	7.77	556	531	508	374	280	14.7	12.7	4,815	504
100	3.35	-67	2.39	3.46	3.46	2.29	8.27	589	562	538	396	298	15.5	13.5	5,350	560
120	3.67	-73	2.39	3.86	3.21	2.56	9.22	651	622	595	438	332	17.0	14.9	6,420	672
140	3.97	-79	1.91	5.29	3.78	2.80	10.11	746	712	681	501	364	19.7	18.2	7,490	784
Mid-lactation (Single lamb; milk yield = 0.47 to 0.89 kg/d)																
40	0.47	0	1.91	1.20	3.01	0.64	2.30	134	128	123	90	83	3.5	3.1	2,140	224
50	0.53	0	1.91	1.40	2.80	0.74	2.68	154	147	141	104	96	3.9	3.6	2,675	280
60	0.58	0	1.91	1.58	2.63	0.84	3.02	172	164	157	116	109	4.3	4.0	3,210	336
70	0.63	0	1.91	1.75	2.51	0.93	3.35	190	181	173	128	121	4.6	4.4	3,745	392
80	0.67	0	1.91	1.91	2.39	1.02	3.66	206	196	188	138	132	5.0	4.8	4,280	448

90	0.71	0	1.91	2.07	2.30	1.10	3.96	221	211	202	149	143	5.3	5.2	4,815	504
100	0.75	0	1.91	2.22	2.22	1.18	4.25	237	226	216	159	153	5.6	5.6	5,350	560
120	0.82	0	1.91	2.51	2.10	1.33	4.81	266	254	243	179	173	6.2	6.3	6,420	672
140	0.89	0	1.91	2.79	2.00	1.48	5.34	294	281	269	198	193	6.8	6.9	7,490	784

Mid-lactation (Twin lambs; milk yield = 0.79 to 1.48 kg/d)

40	0.79	0	1.91	1.50	3.74	0.79	2.86	186	177	170	125	103	4.9	4.3	2,140	224
50	0.88	0	1.91	1.72	3.44	0.91	3.29	210	201	192	141	119	5.4	4.9	2,675	280
60	0.97	0	1.91	1.94	3.23	1.03	3.70	235	224	214	158	133	6.0	5.5	3,210	336
70	1.05	0	1.91	2.14	3.05	1.13	4.09	257	245	235	173	147	6.5	6.1	3,745	392
80	1.12	0	1.91	2.33	2.91	1.23	4.45	278	265	254	187	160	6.9	6.6	4,280	448
90	1.19	0	1.91	2.51	2.79	1.33	4.80	298	285	272	200	173	7.4	7.1	4,815	504
100	1.25	0	1.91	2.68	2.68	1.42	5.13	317	303	289	213	185	7.8	7.5	5,350	560
120	1.37	0	1.91	3.02	2.51	1.60	5.77	354	338	323	238	208	8.6	8.4	6,420	672
140	1.48	0	1.91	3.33	2.38	1.77	6.37	389	371	355	261	230	9.3	9.2	7,490	784

Mid-lactation (Three or more lambs; milk yield = 1.03 to 1.92 kg/d)

40	1.03	0	2.39	1.37	3.43	0.91	3.28	213	203	194	143	118	5.5	4.6	2,140	224
50	1.15	0	1.91	1.97	3.93	1.04	3.76	254	242	232	170	136	6.6	6.0	2,675	280
60	1.26	0	1.91	2.20	3.67	1.17	4.21	281	268	257	189	152	7.2	6.6	3,210	336
70	1.36	0	1.91	2.42	3.46	1.28	4.63	307	293	280	206	167	7.8	7.3	3,745	392
80	1.45	0	1.91	2.63	3.29	1.39	5.02	331	316	302	222	181	8.4	7.8	4,280	448
90	1.54	0	1.91	2.83	3.15	1.50	5.41	354	338	324	238	195	8.9	8.4	4,815	504
100	1.63	0	1.91	3.03	3.03	1.61	5.79	378	361	345	254	209	9.4	9.0	5,350	560
120	1.78	0	1.91	3.39	2.83	1.80	6.49	420	401	383	282	234	10.4	10.0	6,420	672
140	1.92	0	1.91	3.74	2.67	1.98	7.14	459	439	419	309	258	11.3	10.9	7,490	784

Mid-lactation (Parlor production only; milk yield = 1.59 to 2.66 kg/d)

50	1.59	0	2.39	1.90	3.79	1.26	4.53	308	294	281	207	163	7.9	6.8	2,675	280
60	1.74	0	2.39	2.11	3.52	1.40	5.05	340	325	311	229	182	8.7	7.5	3,210	336
70	1.88	0	2.39	2.32	3.31	1.54	5.54	371	354	338	249	200	9.4	8.2	3,745	392
80	2.01	0	1.91	3.14	3.93	1.67	6.00	421	401	384	283	216	10.8	10.0	4,280	448
90	2.13	0	1.91	3.37	3.74	1.79	6.44	449	429	410	302	232	11.5	10.7	4,815	504
100	2.25	0	1.91	3.60	3.60	1.91	6.88	477	456	436	321	248	12.1	11.4	5,350	560
120	2.46	0	1.91	4.03	3.36	2.14	7.71	532	508	486	357	278	13.4	12.6	6,420	672
140	2.66	0	1.91	4.41	3.15	2.34	8.44	578	552	528	388	304	14.5	13.8	7,490	784

Late lactation (Single lamb; milk yield = 0.23 to 0.45 kg/d)

40	0.23	10	1.91	1.09	2.72	0.58	2.08	105	100	96	70	75	2.7	2.3	2,140	224
50	0.25	11	1.91	1.26	2.52	0.67	2.40	119	114	109	80	87	3.0	2.7	2,675	280
60	0.28	12	1.91	1.43	2.38	0.76	2.73	135	129	123	91	99	3.3	3.1	3,210	336
70	0.31	14	1.91	1.61	2.29	0.85	3.07	151	144	138	102	111	3.6	3.5	3,745	392
80	0.33	15	1.91	1.76	2.20	0.93	3.36	165	157	150	111	121	3.9	3.8	4,280	448
90	0.35	16	1.91	1.91	2.12	1.01	3.65	178	170	163	120	132	4.2	4.1	4,815	504
100	0.37	17	1.91	2.05	2.05	1.09	3.93	191	182	175	128	142	4.4	4.4	5,350	560
120	0.41	18	1.91	2.33	1.94	1.23	4.45	216	206	197	145	160	4.9	5.0	6,420	672
140	0.45	20	1.91	2.60	1.86	1.38	4.97	242	231	221	162	179	5.4	5.6	7,490	784

Late lactation (Twin lambs; milk yield = 0.38 to 0.75 kg/d)

40	0.38	25	1.91	1.38	3.45	0.73	2.64	142	136	130	96	95	3.7	3.2	2,140	224
50	0.43	28	1.91	1.60	3.20	0.85	3.06	163	156	149	110	110	4.2	3.7	2,675	280

TABLE 15-1 continued

Class/Age/Other	Body Weight ^c kg	Birth Weight or Milk Yield ^b kg	Body Weight Gain ^c g/d	Energy Concentration in Diet ^d kcal/kg	Daily Dry Matter Intake ^e kg	Energy Requirements ^f		Protein Requirements ^g				Mineral Requirements ^h		Vitamin Requirements ⁱ		
						TDN kg/d	ME Mcal/d	CP @20% UIP g/d	CP @40% UIP g/d	CP @60% UIP g/d	MP g/d	DIP g/d	Ca g/d	P g/d	A RE/d	E IU/d
60	0.47	31	1.91	1.80	3.00	0.95	3.44	182	174	167	123	124	4.6	4.2	3,210	336
70	0.51	34	1.91	2.00	2.85	1.06	3.82	201	192	184	135	138	5.0	4.6	3,745	392
80	0.55	37	1.91	2.19	2.74	1.16	4.18	220	210	201	148	151	5.4	5.1	4,280	448
90	0.59	39	1.91	2.37	2.63	1.25	4.52	237	226	217	159	163	5.8	5.5	4,815	504
100	0.62	41	1.91	2.53	2.53	1.34	4.84	253	241	231	170	174	6.2	5.9	5,350	560
120	0.69	46	1.91	2.87	2.39	1.52	5.49	286	273	261	192	198	6.9	6.6	6,420	672
140	0.75	50	1.91	3.19	2.28	1.69	6.09	317	302	289	213	220	7.5	7.4	7,490	784
Late lactation (Three or more lambs; milk yield = 0.55 to 0.97 kg/d)																
50	0.55	40	1.91	1.83	3.67	0.97	3.51	193	185	177	130	126	5.0	4.4	2,675	280
60	0.61	44	1.91	2.06	3.44	1.09	3.95	217	207	198	146	142	5.6	5.0	3,210	336
70	0.67	48	1.91	2.29	3.27	1.21	4.38	239	229	219	161	158	6.1	5.5	3,745	392
80	0.72	52	1.91	2.50	3.13	1.33	4.78	261	249	238	175	172	6.6	6.0	4,280	448
90	0.76	55	1.91	2.69	2.99	1.43	5.14	279	266	255	187	185	7.0	6.5	4,815	504
100	0.81	59	1.91	2.89	2.89	1.53	5.53	300	286	274	201	199	7.4	6.9	5,350	560
120	0.90	65	1.91	3.26	2.72	1.73	6.24	337	322	308	227	225	8.3	7.8	6,420	672
140	0.97	70	1.91	3.59	2.57	1.91	6.87	370	353	338	249	248	9.0	8.6	7,490	784
Late lactation (Parlor production only; milk yield = 0.85 to 1.35 kg/d)																
60	0.85	50	1.91	2.35	3.91	1.24	4.48	261	249	238	175	162	6.8	6.0	3,210	336
70	0.92	54	1.91	2.58	3.69	1.37	4.93	285	272	260	192	178	7.3	6.6	3,745	392
80	0.99	59	1.91	2.82	3.52	1.50	5.39	310	296	283	208	194	7.9	7.2	4,280	448
90	1.06	62	1.91	3.04	3.37	1.61	5.80	333	318	304	224	209	8.5	7.7	4,815	504
100	1.12	66	1.91	3.25	3.25	1.72	6.21	356	339	325	239	224	9.0	8.3	5,350	560
120	1.24	73	1.91	3.66	3.05	1.94	6.99	399	381	364	268	252	10.0	9.3	6,420	672
140	1.35	80	1.91	4.05	2.89	2.15	7.74	440	420	402	296	279	10.9	10.2	7,490	784
Yearling Farm Ewes																
Maintenance only																
40	0	0	1.91	0.8216	2.05	0.44	1.57	60	58	55	41	57	1.8	1.4	1,256	212
50	0	0	1.91	0.9713	1.94	0.51	1.86	71	68	65	48	67	2.1	1.6	1,570	265
60	0	0	1.91	1.1136	1.86	0.59	2.13	81	77	74	54	77	2.3	1.9	1,884	318
70	0	0	1.91	1.2501	1.79	0.66	2.39	91	87	83	61	86	2.5	2.2	2,198	371
80	0	0	1.91	1.3818	1.73	0.73	2.64	101	96	92	68	95	2.7	2.4	2,512	424
90	0	0	1.91	1.5094	1.68	0.80	2.89	110	105	101	74	104	2.9	2.6	2,826	477
100	0	0	1.91	1.6335	1.63	0.87	3.12	119	114	109	80	113	3.1	2.9	3,140	530
120	0	0	1.91	1.8729	1.56	0.99	3.58	137	131	126	92	129	3.5	3.3	3,768	636

Values for maintenance plus growth, breeding, and pregnancy plus growth in yearling ewes are included in Table 15-2.

Early lactation (Single lamb; milk yield = 0.71 to 1.22 kg/d)

40	0.71	-14	1.91	1.41	3.53	0.75	2.70	167	159	152	112	97	4.5	4.0	2,140	224
50	0.79	-16	1.91	1.63	3.25	0.86	3.11	189	180	172	127	112	5.0	4.6	2,675	280
60	0.87	-17	1.91	1.84	3.06	0.97	3.51	211	202	193	142	127	5.5	5.1	3,210	336
70	0.94	-19	1.91	2.03	2.90	1.08	3.88	231	221	211	155	140	6.0	5.6	3,745	392
80	1.00	-20	1.91	2.21	2.76	1.17	4.23	250	239	228	168	152	6.4	6.1	4,280	448
90	1.06	-21	1.91	2.39	2.65	1.27	4.57	268	256	245	180	165	6.8	6.6	4,815	504
100	1.12	-22	1.91	2.56	2.56	1.36	4.90	287	274	262	193	177	7.2	7.0	5,350	560
120	1.22	-24	1.91	2.88	2.40	1.53	5.51	320	305	292	215	199	8.0	7.8	6,420	672

Early lactation (Twin lambs; milk yield = 1.18 to 2.05 kg/d)

40	1.18	-24	2.39	1.44	3.60	0.95	3.44	224	214	205	151	124	6.0	5.1	2,140	224
50	1.32	-26	2.39	1.65	3.31	1.10	3.96	255	243	232	171	143	6.7	5.8	2,675	280
60	1.45	-29	1.91	2.32	3.86	1.23	4.43	298	284	272	200	160	8.0	7.3	3,210	336
70	1.56	-31	1.91	2.55	3.64	1.35	4.87	324	310	296	218	175	8.6	7.9	3,745	392
80	1.67	-33	1.91	2.77	3.46	1.47	5.29	350	335	320	236	191	9.3	8.6	4,280	448
90	1.77	-35	1.91	2.98	3.31	1.58	5.70	375	358	342	252	205	9.8	9.2	4,815	504
100	1.87	-37	1.91	3.19	3.19	1.69	6.09	399	381	364	268	220	10.4	9.8	5,350	560
120	2.05	-41	1.91	3.57	2.98	1.89	6.83	444	424	405	298	246	11.5	10.9	6,420	672

Early lactation (Three or more lambs; milk yield = 1.53 to 2.66 kg/d)

40	1.53	-31	2.87	1.39	3.48	1.11	4.00	265	253	242	178	144	7.1	5.7	2,140	224
50	1.72	-34	2.39	1.92	3.84	1.27	4.59	312	298	285	210	166	8.3	7.1	2,675	280
60	1.88	-38	2.39	2.14	3.56	1.42	5.11	344	328	314	231	184	9.1	7.9	3,210	336
70	2.03	-41	2.39	2.35	3.35	1.56	5.61	374	357	342	252	202	9.9	8.6	3,745	392
80	2.17	-43	1.91	3.19	3.98	1.69	6.09	425	406	388	286	220	11.4	10.4	4,280	448
90	2.30	-46	1.91	3.42	3.80	1.81	6.54	454	433	414	305	236	12.1	11.1	4,815	504
100	2.43	-49	1.91	3.65	3.65	1.93	6.98	482	461	441	324	252	12.8	11.8	5,350	560
120	2.66	-53	1.91	4.08	3.40	2.16	7.80	535	511	489	360	281	14.0	13.1	6,420	672

Mid-lactation (Single lamb; milk yield = 0.47 to 0.82 kg/d)

40	0.47	0	1.91	1.25	3.12	0.66	2.38	135	129	124	91	86	3.5	3.2	2,140	224
50	0.53	0	1.91	1.45	2.90	0.77	2.77	156	148	142	105	100	4.0	3.7	2,675	280
60	0.58	0	1.91	1.64	2.73	0.87	3.13	174	166	159	117	113	4.4	4.1	3,210	336
70	0.63	0	1.91	1.82	2.60	0.96	3.48	192	183	175	129	125	4.7	4.6	3,745	392
80	0.67	0	1.91	1.99	2.48	1.05	3.80	208	198	190	139	137	5.1	5.0	4,280	448
90	0.71	0	1.91	2.15	2.39	1.14	4.11	223	213	204	150	148	5.4	5.4	4,815	504
100	0.75	0	1.91	2.31	2.31	1.22	4.42	239	228	218	161	159	5.7	5.7	5,350	560
120	0.82	0	1.91	2.61	2.18	1.38	4.99	268	256	245	180	180	6.3	6.4	6,420	672

Mid-lactation (Twin lambs; milk yield = 0.79 to 1.37 kg/d)

40	0.79	0	1.91	1.54	3.85	0.82	2.94	187	178	171	125	106	4.9	4.4	2,140	224
50	0.89	0	1.91	1.78	3.56	0.94	3.40	213	204	195	143	123	5.5	5.0	2,675	280
60	0.97	0	1.91	1.99	3.32	1.06	3.81	236	225	216	159	137	6.0	5.6	3,210	336
70	1.05	0	1.91	2.20	3.15	1.17	4.21	259	247	236	174	157	6.6	6.2	3,745	392
80	1.12	0	1.91	2.40	3.00	1.27	4.59	280	267	255	188	165	7.0	6.7	4,280	448
90	1.19	0	1.91	2.59	2.88	1.37	4.95	300	287	274	202	178	7.5	7.2	4,815	504
100	1.25	0	1.91	2.77	2.77	1.47	5.29	319	305	291	214	191	7.9	7.7	5,350	560
120	1.37	0	1.91	3.12	2.60	1.65	5.96	356	340	325	240	215	8.7	8.6	6,420	672

TABLE 15-1 continued

Class/Age/Other	Body Weight ^a kg	Birth Weight or Milk Yield ^b kg	Body Weight Gain ^c g/d	Energy Concentration in Diet ^d kcal/kg	Daily Dry Matter Intake ^e		Energy Requirements ^f		Protein Requirements ^g				Mineral Requirements ^h		Vitamin Requirements ⁱ		
					kg	% BW	TDN kg/d	ME Mcal/d	CP @20% UIP g/d	CP @40% UIP g/d	CP @60% UIP g/d	MP g/d	DIP g/d	Ca g/d	P g/d	A RE/d	E IU/d
Mid-lactation (Three or more lambs; milk yield = 1.03 to 1.78 kg/d)																	
40	1.03	0	2.39	1.41	3.52	0.93	3.36	213	204	195	143	121	5.5	4.7	2.140	224	
50	1.15	0	2.39	1.61	3.23	1.07	3.86	241	230	220	162	139	6.1	5.3	2,675	280	
60	1.26	0	1.91	2.26	3.77	1.20	4.32	283	270	258	190	156	7.3	6.7	3,210	336	
70	1.36	0	1.91	2.49	3.55	1.32	4.76	309	295	282	207	171	7.9	7.4	3,745	392	
80	1.45	0	1.91	2.70	3.38	1.43	5.16	333	317	304	223	186	8.5	8.0	4,280	448	
90	1.54	0	1.91	2.91	3.23	1.54	5.56	356	340	325	240	201	9.0	8.5	4,815	504	
100	1.62	0	1.91	3.11	3.11	1.65	5.94	378	361	346	254	214	9.5	9.1	5,350	560	
120	1.78	0	1.91	3.49	2.91	1.85	6.67	422	403	385	284	241	10.5	10.1	6,420	672	
Late lactation (Single lamb; milk yield = 0.23 to 0.41 kg/d)																	
40	0.23	60	1.91	1.55	3.86	0.82	2.95	142	135	129	95	107	3.9	2.5	2,140	224	
50	0.25	61	1.91	1.83	3.65	0.97	3.49	165	158	151	111	126	4.4	2.9	2,675	280	
60	0.28	72	1.91	2.11	3.52	1.12	4.03	190	181	173	128	145	5.0	3.4	3,210	336	
70	0.31	84	1.91	2.40	3.42	1.27	4.58	215	205	197	145	165	5.6	3.8	3,745	392	
80	0.33	95	1.91	2.66	3.32	1.41	5.09	238	227	217	160	183	6.1	4.3	4,280	448	
90	0.35	106	1.91	2.92	3.24	1.55	5.58	260	248	238	175	201	6.6	4.7	4,815	504	
100	0.37	117	1.91	3.17	3.17	1.68	6.07	283	270	258	190	219	7.2	5.1	5,350	560	
120	0.41	138	1.91	3.67	3.06	1.94	7.01	326	311	297	219	253	8.2	5.9	6,420	672	
Late lactation (Twin lambs; milk yield = 0.38 to 0.69 kg/d)																	
40	0.38	65	2.39	1.47	3.68	0.97	3.51	167	159	152	112	127	4.4	2.8	2,140	224	
50	0.43	78	2.39	1.73	3.47	1.15	4.14	195	186	178	131	149	5.0	3.3	2,675	280	
60	0.47	91	2.39	1.98	3.31	1.32	4.74	221	211	201	148	171	5.7	3.8	3,210	336	
70	0.51	104	1.91	2.79	3.98	1.48	5.33	265	253	242	178	192	7.0	4.8	3,745	392	
80	0.55	117	1.91	3.09	3.86	1.64	5.91	293	279	267	197	213	7.6	5.4	4,280	448	
90	0.59	129	1.91	3.38	3.75	1.79	6.46	319	305	292	215	233	8.3	5.8	4,815	504	
100	0.62	141	1.91	3.65	3.65	1.94	6.98	344	328	314	231	252	8.9	6.3	5,350	560	
120	0.69	166	1.91	4.21	3.51	2.23	8.06	396	378	361	266	290	10.1	7.2	6,420	672	
Late lactation (Three or more lambs; milk yield = 0.55 to 0.90 kg/d)																	
50	0.55	90	2.39	1.92	3.84	1.27	4.59	223	213	203	150	166	5.8	3.9	2,675	280	
60	0.61	104	2.39	2.19	3.66	1.45	5.25	253	241	231	170	189	6.6	4.4	3,210	336	
70	0.67	118	2.39	2.46	3.52	1.63	5.89	282	270	258	190	212	7.2	4.9	3,745	392	
80	0.72	132	2.39	2.72	3.40	1.80	6.50	310	296	283	209	234	7.9	5.4	4,280	448	
90	0.76	145	2.39	2.96	3.29	1.96	7.07	336	321	307	226	255	8.5	5.8	4,815	504	
100	0.81	159	2.39	3.21	3.21	2.13	7.67	363	347	332	244	277	9.2	6.3	5,350	560	
120	0.90	185	1.91	4.60	3.84	2.44	8.80	446	426	407	300	317	11.5	8.3	6,420	672	
Yearling Range Ewes Maintenance only																	
40		0	1.91	0.80	1.99	0.42	1.52	60	57	55	40	55	1.8	1.3	1,256	212	
50		0	1.91	0.94	1.89	0.50	1.80	70	67	64	47	65	2.0	1.6	1,570	265	

60	0	1.91	1.08	1.80	0.57	2.07	80	77	73	54	74	2.3	1.8	1,884	318
70	0	1.91	1.21	1.73	0.64	2.32	90	86	82	60	84	2.5	2.1	2,198	371
80	0	1.91	1.34	1.68	0.71	2.56	99	95	91	67	92	2.7	2.3	2,512	424
90	0	1.91	1.46	1.63	0.78	2.80	109	104	99	73	101	2.9	2.5	2,826	477
100	0	1.91	1.59	1.59	0.84	3.03	118	113	108	79	109	3.0	2.8	3,140	530
120	0	1.91	1.82	1.51	0.96	3.48	136	130	124	91	125	3.4	3.2	3,768	636

Values for maintenance plus growth, breeding, and pregnancy plus growth in yearling ewes are included in Table 15-2.

Early lactation (Single lamb; milk yield = 0.71 to 1.22 kg/d)

40	0.71	-14	1.39	3.47	0.74	2.66	166	159	152	112	96	4.4	3.9	2,140	224
50	0.79	-16	1.60	3.20	0.85	3.06	188	180	172	127	110	5.0	4.5	2,675	280
60	0.87	-17	1.81	3.01	0.96	3.45	211	201	192	142	125	5.5	5.1	3,210	336
70	0.94	-19	1.99	2.85	1.06	3.81	231	220	211	155	137	5.9	5.6	3,745	392
80	1.00	-20	1.91	2.72	1.15	4.16	249	238	228	167	150	6.4	6.0	4,280	448
90	1.06	-21	1.91	2.35	1.24	4.49	268	255	244	180	162	6.8	6.5	4,815	504
100	1.12	-22	1.91	2.52	1.34	4.82	286	273	261	192	174	7.2	6.9	5,350	560
120	1.22	-24	1.91	2.83	1.50	5.42	319	304	291	214	195	7.9	7.7	6,420	672

Early lactation (Twin lambs; milk yield = 1.18 to 2.05 kg/d)

40	1.18	-24	2.39	1.42	0.94	3.40	224	214	205	151	123	6.0	5.0	2,140	224
50	1.32	-26	2.39	1.63	1.08	3.91	254	243	232	171	141	6.7	5.7	2,675	280
60	1.45	-29	1.91	2.29	1.21	4.37	297	284	271	200	158	7.9	7.2	3,210	336
70	1.56	-31	1.91	2.51	1.33	4.80	324	309	295	217	173	8.6	7.9	3,745	392
80	1.67	-33	1.91	2.73	1.45	5.22	350	334	319	235	188	9.2	8.5	4,280	448
90	1.77	-35	1.91	2.94	1.56	5.62	374	357	341	251	203	9.8	9.1	4,815	504
100	1.87	-37	1.91	3.14	1.67	6.01	398	380	364	268	217	10.3	9.7	5,350	560
120	2.05	-41	1.91	3.52	1.87	6.74	443	423	404	298	243	11.4	10.8	6,420	672

Early lactation (Three or more lambs; milk yield = 1.53 to 2.66 kg/d)

40	1.53	-31	2.87	1.38	3.45	3.96	265	253	242	178	143	7.1	5.7	2,140	224
50	1.72	-34	2.39	1.90	3.80	4.54	312	298	285	210	164	8.3	7.1	2,675	280
60	1.88	-38	2.39	2.11	3.52	5.05	344	328	314	231	182	9.1	7.8	3,210	336
70	2.03	-41	2.39	2.32	3.32	5.55	374	357	342	251	200	9.8	8.5	3,745	392
80	2.17	-43	1.91	3.15	3.94	6.02	425	405	388	285	217	11.3	10.4	4,280	448
90	2.30	-46	1.91	3.38	3.75	6.46	453	433	414	305	233	12.0	11.1	4,815	504
100	2.43	-49	1.91	3.61	3.61	6.89	482	460	440	324	249	12.7	11.8	5,350	560
120	2.66	-53	1.91	4.03	3.36	7.71	534	510	488	359	278	14.0	13.0	6,420	672

Mid-lactation (Single lamb; milk yield = 0.47 to 0.82 kg/d)

40	0.47	0	1.91	1.22	3.06	2.34	135	129	123	91	84	3.5	3.1	2,140	224
50	0.53	0	1.91	1.42	2.85	2.72	155	148	142	104	98	3.9	3.6	2,675	280
60	0.58	0	1.91	1.61	2.68	3.07	173	165	158	116	111	4.3	4.1	3,210	336
70	0.63	0	1.91	1.79	2.55	3.41	191	182	174	128	123	4.7	4.5	3,745	392
80	0.67	0	1.91	1.95	2.44	3.73	207	197	189	139	134	5.0	4.9	4,280	448
90	0.71	0	1.91	2.11	2.34	4.03	223	212	203	150	145	5.4	5.3	4,815	504
100	0.75	0	1.91	2.27	2.27	4.33	238	227	217	160	156	5.7	5.7	5,350	560
120	0.82	0	1.91	2.56	2.14	4.90	267	255	244	180	177	6.3	6.4	6,420	672

TABLE 15-1 continued

Class/Age/Other	Body Weight ^e kg	Birth Weight or Milk Yield ^b kg	Body Weight Gain ^c g/d	Energy Concentration in Diet ^d kcal/kg	Daily Dry Matter Intake ^e kg	Energy Requirements ^f		Protein Requirements ^g				Mineral Requirements ^h		Vitamin Requirements ⁱ		
						TDN kg/d	ME Mcal/d	CP @20% UIP g/d	CP @40% UIP g/d	CP @60% UIP g/d	MP g/d	DIP g/d	Ca g/d	P g/d	A RE/d	E IU/d
Mid-lactation (Twin lambs; milk yield = 0.79 to 1.37 kg/d)																
40	0.79	0	1.91	1.52	3.79	0.80	2.90	186	178	170	125	105	4.9	4.4	2,140	224
50	0.89	0	1.91	1.75	3.51	0.93	3.35	213	203	194	143	121	5.5	5.0	2,675	280
60	0.97	0	1.91	1.96	3.27	1.04	3.76	236	225	215	158	135	6.0	5.6	3,210	336
70	1.05	0	1.91	2.17	3.10	1.15	4.15	258	246	236	174	150	6.5	6.1	3,745	392
80	1.12	0	1.91	2.36	2.95	1.25	4.52	279	266	255	187	163	7.0	6.6	4,280	448
90	1.19	0	1.91	2.55	2.83	1.35	4.87	300	286	274	201	176	7.4	7.1	4,815	504
100	1.25	0	1.91	2.72	2.72	1.44	5.21	318	304	291	214	188	7.9	7.6	5,350	560
120	1.37	0	1.91	3.07	2.55	1.63	5.86	356	339	325	239	211	8.7	8.5	6,420	672
Mid-lactation (Three or more lambs; milk yield = 1.03 to 1.78 kg/d)																
40	1.03	0	2.39	1.39	3.47	0.92	3.32	213	203	195	143	120	5.5	4.6	2,140	224
50	1.15	0	1.91	1.99	3.98	1.06	3.81	254	243	232	171	137	6.6	6.0	2,675	280
60	1.26	0	1.91	2.23	3.72	1.18	4.26	282	269	258	190	154	7.3	6.7	3,210	336
70	1.36	0	1.91	2.45	3.51	1.30	4.69	308	294	281	207	169	7.9	7.3	3,745	392
80	1.45	0	1.91	2.66	3.33	1.41	5.09	332	317	303	223	184	8.4	7.9	4,280	448
90	1.54	0	1.91	2.87	3.19	1.52	5.49	356	340	325	239	198	9.0	8.5	4,815	504
100	1.62	0	1.91	3.06	3.06	1.62	5.86	378	361	345	254	211	9.5	9.0	5,350	560
120	1.78	0	1.91	3.44	2.87	1.82	6.58	421	402	385	283	237	10.4	10.0	6,420	672
Late lactation (Single lamb; milk yield = 0.23 to 0.41 kg/d)																
40	0.23	50	1.91	1.52	3.81	0.81	2.91	141	135	129	95	105	3.7	2.4	2,140	224
50	0.25	61	1.91	1.80	3.60	0.95	3.44	165	157	150	111	124	4.3	2.9	2,675	280
60	0.28	72	1.91	2.08	3.46	1.10	3.97	189	181	173	127	143	4.9	3.3	3,210	336
70	0.31	84	1.91	2.36	3.37	1.25	4.52	215	205	196	144	163	5.5	3.8	3,745	392
80	0.33	95	1.91	2.62	3.28	1.39	5.01	237	227	217	159	181	6.1	4.2	4,280	448
90	0.35	106	1.91	2.88	3.20	1.53	5.50	260	248	237	175	198	6.6	4.6	4,815	504
100	0.37	117	1.91	3.13	3.13	1.66	5.98	282	269	257	189	216	7.1	5.0	5,350	560
120	0.41	138	1.91	3.61	3.01	1.92	6.91	325	310	297	218	249	8.1	5.8	6,420	672
Late lactation (Twin lambs; milk yield = 0.38 to 0.69 kg/d)																
40	0.38	65	2.39	1.45	3.63	0.96	3.47	167	159	152	112	125	4.3	2.8	2,140	224
50	0.43	78	2.39	1.71	3.42	1.13	4.09	194	186	177	131	148	5.0	3.3	2,675	280
60	0.47	91	2.39	1.96	3.27	1.30	4.68	220	210	201	148	169	5.6	3.7	3,210	336
70	0.51	104	1.91	2.75	3.93	1.46	5.26	265	253	242	178	190	6.9	4.8	3,745	392
80	0.55	117	1.91	3.05	3.81	1.62	5.83	292	279	267	196	210	7.6	5.3	4,280	448
90	0.59	129	1.91	3.34	3.71	1.77	6.38	319	304	291	214	230	8.2	5.8	4,815	504
100	0.62	141	1.91	3.61	3.61	1.91	6.90	344	328	314	231	249	8.9	6.3	5,350	560
120	0.69	166	1.91	4.16	3.47	2.21	7.96	395	377	361	265	287	10.1	7.2	6,420	672
Late lactation (Three or more lambs; milk yield = 0.55 to 0.90 kg/d)																
50	0.55	90	2.39	1.90	3.80	1.26	4.54	223	213	203	150	164	5.8	3.8	2,675	280
60	0.61	104	2.39	2.17	3.62	1.44	5.19	253	241	231	170	187	6.5	4.4	3,210	336

70	0.67	118	2.39	2.44	3.48	1.61	5.82	282	270	258	190	210	7.2	4.9	3,745	392
80	0.72	132	2.39	2.69	3.36	1.78	6.43	310	296	283	209	232	7.9	5.3	4,280	448
90	0.76	145	2.39	2.93	3.25	1.94	6.99	336	320	307	226	252	8.5	5.8	4,815	504
100	0.81	159	1.91	3.97	3.97	2.10	7.59	390	372	356	262	274	10.1	7.2	5,350	560
120	0.90	185	1.91	4.55	3.79	2.41	8.70	446	425	407	300	314	11.5	8.2	6,420	672
Rams																
Maintenance																
100	0	0	1.91	1.77	1.77	0.94	3.38	128	122	117	86	122	3.3	3.1	3,140	530
125	0	0	1.91	2.09	1.67	1.11	4.00	152	145	139	102	144	3.8	3.7	3,925	663
150	0	0	1.91	2.40	1.60	1.27	4.58	175	168	160	118	165	4.3	4.3	4,710	795
200	0	0	1.91	2.98	1.49	1.58	5.69	220	210	201	148	205	5.2	5.3	6,280	1,060
Prebreeding																
100	47	47	1.91	1.95	1.95	1.03	3.72	150	144	137	101	134	3.6	3.4	4,550	560
125	56	56	1.91	2.30	1.84	1.22	4.40	179	171	163	120	159	4.2	4.1	5,688	700
150	64	64	1.91	2.64	1.76	1.40	5.04	206	197	188	139	182	4.7	4.7	6,825	840
200	79	79	1.91	3.27	1.64	1.74	6.26	259	247	236	174	226	5.7	5.9	9,100	1,120

^aBody weight used in estimating requirements is the determined or estimated weight in kilograms (kg) average for the period during which these requirements will be applied.

^bBirth weight (kg) of single and average of multiple lambs or liquid milk yield (kg/d).

^cAverage change in body weight over a 24-hour period.

^dThree hypothetical diets with increasing energy concentrations (1.91, 2.34, and 2.87 kcal/kg) were used in the calculations of intake and nutrient requirements. For each line entry, a diet was selected to represent the level of energy concentration that approximates that needed by the animal to achieve adequate intake to satisfy its energy requirement.

^eThe daily dry matter intake, expressed as kg or as percentage of body weight, of a diet having the indicated energy concentration (previous column) that is required to meet energy requirements. These energy concentrations should be viewed only as examples. In some cases, diets having greater or lesser concentrations of energy would be more appropriate.

^fEnergy requirements expressed as total digestible nutrients (TDN) in kg/d and metabolizable energy (ME) as kcal/d.

^gProtein requirements expressed as crude protein (CP), metabolizable protein (MP), and degradable intake protein (DIP). The CP requirement differs with the proportion of undegradable intake protein (UIP) because of the required minimal DIP.

^hTwo macro minerals, calcium (Ca) and phosphorus (P), commonly considered in balancing diets are included. Often, the balance (ratio) of the two minerals also is of concern.

ⁱTwo fat-soluble vitamins, A and E, that often are deficient in animal diets are expressed as retinol equivalents (RE) and international units (IU) for vitamins A and E, respectively. RE = 1.0 µg of all-trans retinol, 5.0 µg of all-trans beta-carotene, and 7.6 µg of other carotenoids.

TABLE 15-2 Nutrient Requirements of Sheep (growing, finishing lambs, and yearlings during growth/gestation)

Class/Age/Other	Body Weight ^a kg	Birth Weight or Milk Yield ^b kg	Energy Concentration in Diet ^{c,d} kcal/kg	Energy Requirements ^e				Protein Requirements ^h				Mineral Requirements ⁱ		Vitamin Requirements ^j								
				TDN kg/d	ME Mcal/d	NEm Mcal/d	NEg Mcal/d	CP @20% UIP g/d	CP @40% UIP g/d	CP @60% UIP g/d	MP g/d	DIP g/d	Ca g/d	P g/d	A RE/d	E IU/d						
																	Daily Dry Matter Intake ^f kg	% BW				
Growing Lambs and Yearlings																						
Age = 4 months	20	100	1.91	0.30	1.09	0.20	0.21	0.57	2.86	0.30	1.09	0.20	0.21	76	73	69	51	39	2.3	1.5	2,000	200
Maturity = 0.3 (late maturing)	20	150	1.91	0.41	1.50	0.21	0.32	0.78	3.91	0.41	1.50	0.21	0.32	104	99	95	70	54	3.1	2.2	2,000	200
	20	200	2.39	0.39	1.42	0.21	0.42	0.59	2.97	0.39	1.42	0.21	0.42	116	111	106	78	51	3.7	2.5	2,000	200
	20	300	2.87	0.61	3.04	0.21	0.63	0.61	3.04	0.48	1.74	0.21	0.63	155	148	142	104	63	5.1	3.5	2,000	200
	30	200	1.91	0.56	2.02	0.29	0.42	1.05	3.51	0.56	2.02	0.29	0.42	137	131	125	92	73	4.1	2.9	3,000	300
	30	250	2.39	0.50	1.82	0.29	0.53	0.76	2.53	0.50	1.82	0.29	0.53	145	139	133	98	65	4.5	3.2	3,000	300
	30	300	2.39	0.58	2.10	0.29	0.63	0.88	2.93	0.58	2.10	0.29	0.63	169	162	155	114	76	5.3	3.8	3,000	300
	30	400	2.39	0.74	2.67	0.30	0.84	1.12	3.72	0.74	2.67	0.30	0.84	218	208	199	146	96	6.9	5.0	3,000	300
	40	250	1.91	0.70	2.53	0.37	0.53	1.32	3.31	0.70	2.53	0.37	0.53	171	163	156	115	91	5.0	3.7	4,000	400
	40	300	1.91	0.82	2.94	0.38	0.63	1.54	3.84	0.82	2.94	0.38	0.63	199	190	182	134	106	5.9	4.4	4,000	400
	40	400	2.39	1.16	2.78	0.38	0.84	1.16	2.91	1.16	2.78	0.38	0.84	223	213	204	150	100	7.0	5.1	4,000	400
	40	500	2.39	1.40	3.51	0.93	1.05	1.40	3.51	0.93	3.35	0.39	1.05	271	259	248	182	121	8.6	6.3	4,000	400
	50	250	1.91	0.73	2.64	0.44	0.53	1.38	2.76	0.73	2.64	0.44	0.53	177	169	161	119	95	5.1	3.8	5,000	500
	50	300	1.91	0.85	3.05	0.45	0.63	1.59	3.19	0.85	3.05	0.45	0.63	205	195	187	137	110	6.0	4.5	5,000	500
	50	400	2.39	1.21	2.42	0.80	0.84	1.21	2.42	1.21	2.42	0.80	0.84	228	218	208	153	104	7.0	5.1	5,000	500
	50	500	2.39	1.45	3.47	0.47	1.05	1.45	2.90	1.45	3.47	0.47	1.05	277	264	253	186	125	8.6	6.3	5,000	500
	60	250	1.91	0.96	3.47	0.47	0.53	1.69	3.38	1.12	4.04	0.48	1.26	325	310	297	219	146	10.2	7.6	5,000	500
	60	300	1.91	1.12	4.04	0.48	0.53	1.43	2.39	1.12	4.04	0.48	0.53	310	297	282	219	146	10.2	7.6	5,000	500
	60	400	1.91	1.65	2.75	0.87	0.63	1.65	2.75	1.65	2.75	0.87	0.63	382	370	358	282	190	12.2	9.1	6,000	600
	60	500	1.91	2.08	3.47	1.10	0.84	2.08	3.47	1.10	3.98	0.55	0.84	466	454	443	358	243	17.9	14.3	6,000	600
	60	600	2.39	1.49	2.49	0.99	0.53	1.49	2.49	1.49	2.49	0.99	0.53	330	315	302	222	150	10.3	7.6	6,000	600
	70	150	1.91	1.15	4.15	0.55	1.26	1.74	2.90	1.15	4.15	0.55	1.26	330	315	302	222	150	10.3	7.6	6,000	600
	70	200	1.91	1.55	2.00	0.53	0.32	1.70	2.43	1.55	2.00	0.53	0.32	330	315	302	222	150	10.3	7.6	6,000	600
	70	300	1.91	1.80	2.42	0.55	0.42	1.70	2.43	1.80	2.42	0.55	0.42	330	315	302	222	150	10.3	7.6	6,000	600
	70	400	1.91	2.43	0.90	0.58	0.63	2.14	3.05	2.43	0.90	0.58	0.63	330	315	302	222	150	10.3	7.6	6,000	600
	70	500	1.91	2.57	3.68	1.13	0.84	2.14	3.05	2.57	3.68	1.13	0.84	330	315	302	222	150	10.3	7.6	6,000	600
	80	150	1.91	1.36	2.08	0.59	0.32	1.09	1.36	1.36	2.08	0.59	0.32	137	130	125	92	75	9.6	7.4	7,000	700
	80	200	1.91	1.64	2.50	0.61	0.42	1.31	1.64	1.64	2.50	0.61	0.42	165	157	150	111	90	4.3	3.2	8,000	800
	80	300	1.91	1.75	2.19	0.64	0.63	1.75	2.19	1.75	2.19	0.64	0.63	221	211	202	149	121	6.1	4.6	8,000	800
	80	400	1.91	2.19	2.74	1.16	0.84	2.19	2.74	2.19	2.74	1.16	0.84	277	265	253	186	151	7.9	6.0	8,000	800
	80	500	1.91	2.63	3.29	1.39	1.05	2.63	3.29	2.63	3.29	1.39	1.05	334	318	305	224	181	9.7	7.5	8,000	800
Age = 4 months																						
Maturity = 0.6 (early maturing)	20	100	2.39	0.42	1.51	0.21	0.46	0.63	3.16	0.42	1.51	0.21	0.46	70	66	64	47	55	2.1	1.5	2,000	200
	20	150	2.87	0.52	1.87	0.21	0.68	0.65	3.25	0.52	1.87	0.21	0.68	84	80	77	57	67	2.6	2.0	2,000	200
	20	200	2.87	0.83	4.17	0.66	0.91	1.20	6.00	0.66	2.39	0.22	0.91	106	101	97	71	86	3.4	2.7	2,000	200
	20	300	2.87	1.20	6.00	0.95	1.37	1.20	3.99	1.20	3.44	0.24	1.37	149	142	136	100	124	4.9	4.0	2,000	200
	30	200	2.39	0.79	2.86	0.31	0.91	1.20	3.99	0.79	2.86	0.31	0.91	125	119	114	84	103	3.7	3.0	3,000	300
	30	250	2.87	1.06	3.54	0.84	1.14	1.06	3.54	1.06	3.54	0.84	1.14	133	127	122	89	110	4.2	3.4	3,000	300
	30	300	2.87	1.25	4.15	0.99	1.37	1.25	4.15	1.25	4.15	0.99	1.37	155	148	141	104	129	4.9	4.0	3,000	300
	30	400	2.87	1.62	5.38	1.28	1.83	1.62	5.38	1.62	5.38	1.28	1.83	198	189	181	133	167	6.4	5.4	3,000	300
	40	250	2.39	1.00	3.60	0.40	1.14	1.50	3.76	1.00	3.60	0.40	1.14	155	148	142	104	130	4.6	3.8	4,000	400

40	300	2.87	1.29	3.22	1.02	3.69	0.40	1.37	160	153	146	108	133	5.0	4.1	4,000	400
40	400	2.87	1.66	4.15	1.32	4.76	0.43	1.83	204	195	186	137	172	6.4	5.4	4,000	400
40	500	2.87	2.03	5.08	1.62	5.83	0.46	2.28	247	236	226	166	210	7.9	6.7	4,000	400
50	250	2.39	1.55	3.10	1.03	3.71	0.47	1.14	161	154	147	108	134	4.6	3.8	5,000	500
50	300	2.39	1.81	3.63	1.20	4.34	0.49	1.37	186	178	170	125	156	5.4	4.6	5,000	500
50	400	2.87	1.70	3.41	1.35	4.88	0.51	1.83	209	200	191	141	176	6.5	5.4	5,000	500
50	500	2.87	2.08	4.16	1.65	5.96	0.54	2.28	253	242	231	170	215	8.0	6.8	5,000	500
50	600	2.87	2.45	4.91	1.95	7.04	0.58	2.74	297	283	271	199	254	9.5	8.1	5,000	500
60	250	2.39	1.60	2.66	1.06	3.82	0.54	1.14	167	159	152	112	138	4.7	3.9	6,000	600
60	300	2.39	1.86	3.10	1.23	4.45	0.57	1.37	192	183	175	129	160	5.5	4.6	6,000	600
60	400	2.39	2.39	3.98	1.58	5.71	0.61	1.83	242	231	221	163	206	7.1	6.1	6,000	600
60	500	2.87	2.12	3.54	1.69	6.08	0.62	2.28	259	247	236	174	219	8.0	6.8	6,000	600
60	600	2.87	2.50	4.17	1.99	7.17	0.66	2.74	302	289	276	203	258	9.5	8.1	6,000	600
70	150	1.91	1.81	2.59	0.96	3.46	0.59	0.68	152	145	139	102	125	3.7	3.1	7,000	700
70	200	1.91	2.28	3.26	1.21	4.37	0.63	0.91	186	177	170	125	157	4.7	4.1	7,000	700
70	300	2.39	1.91	2.72	1.26	4.55	0.63	1.37	197	188	180	133	164	5.5	4.7	7,000	700
70	400	2.39	2.44	3.48	1.62	5.82	0.69	1.83	248	237	226	167	210	7.1	6.1	7,000	700
70	500	2.87	2.16	3.09	1.72	6.20	0.70	2.28	264	252	241	178	224	8.0	6.8	7,000	700
80	150	1.91	1.86	2.33	0.99	3.56	0.65	0.68	157	150	144	106	128	3.8	3.2	8,000	800
80	200	1.91	2.34	2.92	1.24	4.47	0.69	0.91	192	183	175	129	161	4.8	4.1	8,000	800
80	300	2.39	1.95	2.44	1.29	4.66	0.70	1.37	203	194	185	136	168	5.6	4.7	8,000	800
80	400	2.39	2.48	3.10	1.65	5.94	0.76	1.83	253	242	231	170	214	7.2	6.2	8,000	800
80	500	2.39	3.02	3.77	2.00	7.21	0.82	2.28	304	290	278	204	260	8.8	7.7	8,000	800
20	100	2.39	0.59	2.94	0.39	1.41	0.41	0.30	73	70	67	49	51	2.2	1.5	2,000	200
20	150	2.39	0.76	3.80	0.50	1.81	0.42	0.45	97	93	89	65	65	3.0	2.1	2,000	200
20	200	2.87	0.70	3.48	0.55	1.99	0.43	0.59	112	107	102	75	72	3.5	2.6	2,000	200
20	300	2.87	0.94	4.70	0.75	2.69	0.45	0.89	156	149	142	105	97	5.0	3.8	2,000	200
30	200	2.39	1.03	3.43	0.68	2.46	0.59	0.59	129	123	117	86	89	3.8	2.9	3,000	300
30	250	2.87	0.90	3.01	0.72	2.59	0.59	0.74	141	135	129	95	93	4.4	3.3	3,000	300
30	300	2.87	1.03	3.42	0.82	2.94	0.61	0.89	163	156	149	110	106	5.1	3.9	3,000	300
30	400	2.87	1.27	4.25	1.01	3.66	0.64	1.19	207	198	189	139	132	6.6	5.1	3,000	300
40	250	2.39	1.30	3.25	0.86	3.10	0.75	0.74	160	153	146	108	112	4.7	3.6	4,000	400
40	300	2.39	1.48	3.69	0.98	3.53	0.77	0.89	184	176	168	124	127	5.5	4.3	4,000	400
40	400	2.87	1.36	3.40	1.08	3.90	0.79	1.19	215	205	196	144	140	6.7	5.2	4,000	400
40	500	2.87	1.61	4.03	1.28	4.62	0.83	1.48	259	247	237	174	167	8.2	6.4	4,000	400
50	250	2.39	1.39	2.78	0.92	3.32	0.89	0.74	168	160	153	113	120	4.8	3.7	5,000	500
50	300	2.39	1.57	3.13	1.04	3.74	0.92	0.89	192	183	175	129	135	5.6	4.4	5,000	500
50	400	2.39	1.92	3.85	1.28	4.60	0.97	1.19	240	230	220	162	166	7.2	5.7	5,000	500
50	500	2.87	1.69	3.39	1.35	4.86	0.98	1.48	266	254	243	179	175	8.3	6.5	5,000	500
50	600	2.87	1.95	3.90	1.55	5.59	1.03	1.78	311	297	284	209	202	9.8	7.7	5,000	500
60	250	1.91	2.32	3.87	1.23	4.44	1.08	0.74	208	198	190	140	160	5.7	4.6	6,000	600
60	300	2.39	1.65	2.76	1.10	3.95	1.05	0.89	199	190	182	134	143	5.7	4.5	6,000	600
60	400	2.39	2.02	3.36	1.34	4.82	1.11	1.19	248	237	226	167	174	7.3	5.8	6,000	600
60	500	2.39	2.38	3.97	1.58	5.69	1.17	1.48	297	283	271	199	205	8.9	7.2	6,000	600
60	600	2.87	2.03	3.39	1.62	5.83	1.18	1.78	318	304	290	214	210	9.9	7.8	6,000	600
70	150	1.91	1.78	2.54	0.94	3.40	1.12	0.45	155	148	142	104	122	3.9	3.1	7,000	700
70	200	1.91	2.10	3.01	1.12	4.02	1.17	0.59	185	177	169	125	145	4.8	3.9	7,000	700
70	300	1.91	2.76	3.94	1.46	5.28	1.27	0.89	246	235	225	165	190	6.7	5.5	7,000	700
70	400	2.39	2.11	3.01	1.40	5.03	1.25	1.19	255	244	233	171	181	7.4	5.9	7,000	700

Age = 8 months
Maturity = 0.4
(late maturing)

TABLE 15-2 continued

Class/Age/Other	Body Weight ^e kg	Weight or Milk Yield ^b kg	Body Weight Gain ^{c,d} g/d	Energy Concentration in Diet ^f kcal/kg	Daily Dry Matter Intake/ % BW	Energy Requirements ^g			Protein Requirements ^h			Mineral Requirements ⁱ			Vitamin Requirements ^j				
						TDN kg/d	ME Mcal/d	NEEm Mcal/d	CP @20% UIP g/d	CP @40% UIP g/d	CP @60% UIP g/d	DIP g/d	MP g/d	Ca g/d	P g/d	A RE/d	E IU/d		
	70		500	2.39	2.47	3.53	1.64	5.91	1.31	1.48	304	290	278	204	213	9.0	7.2	7,000	700
	80		150	1.91	1.87	2.34	0.99	3.58	1.24	0.45	163	155	148	109	129	4.0	3.2	8,000	800
	80		200	1.91	2.20	2.75	1.17	4.21	1.29	0.59	193	184	176	130	152	4.9	4.0	8,000	800
	80		300	1.91	2.87	3.58	1.52	5.48	1.40	0.89	254	242	232	171	198	6.8	5.6	8,000	800
	80		400	2.39	2.19	2.74	1.45	5.24	1.38	1.19	262	250	239	176	189	7.5	6.0	8,000	800
	80		500	2.39	2.56	3.20	1.70	6.13	1.45	1.48	312	297	284	209	221	9.1	7.3	8,000	800
	20		100	2.87	0.65	3.27	0.52	1.88	0.45	0.54	68	65	62	46	68	2.0	1.5	2,000	200
	20		150	2.87	0.88	4.39	0.70	2.52	0.49	0.82	89	85	82	60	91	2.7	2.2	2,000	200
	20		200	2.87	1.10	5.51	0.88	3.16	0.52	1.09	111	106	101	74	114	3.5	2.9	2,000	200
	20		300	2.87	1.55	7.75	1.23	4.45	0.59	1.63	146	140	140	103	160	4.9	4.3	2,000	200
	30		200	2.87	1.19	3.97	0.95	3.42	0.70	1.09	119	114	109	80	123	3.5	3.0	3,000	300
	30		250	2.87	1.42	4.73	1.13	4.07	0.75	1.36	140	134	128	94	147	4.3	3.7	3,000	300
	30		300	2.87	1.65	5.49	1.31	4.73	0.80	1.63	162	155	148	109	170	5.0	4.4	3,000	300
	30		400	2.87	2.10	7.02	1.67	6.04	0.89	2.18	205	196	187	138	218	6.5	5.8	3,000	300
	40		250	2.87	1.51	3.77	1.20	4.32	0.93	1.36	149	142	136	100	156	4.4	3.8	4,000	400
	40		300	2.87	1.74	4.34	1.38	4.98	0.99	1.63	170	163	155	114	180	5.1	4.5	4,000	400
	40		400	2.87	2.20	5.50	1.75	6.31	1.11	2.18	214	204	195	144	228	6.6	5.9	4,000	400
	40		500	2.87	2.67	6.66	2.12	7.64	1.22	2.72	257	245	235	173	276	8.1	7.3	4,000	400
	50		250	2.87	1.59	3.17	1.26	4.55	1.10	1.36	156	149	143	105	164	4.4	3.8	5,000	500
	50		300	2.87	1.82	3.64	1.45	5.23	1.17	1.63	178	170	163	120	188	5.2	4.5	5,000	500
	50		400	2.87	2.29	4.58	1.82	6.57	1.31	2.18	222	212	203	149	237	6.7	6.0	5,000	500
	50		500	2.87	2.76	5.53	2.20	7.92	1.45	2.72	266	254	243	179	286	8.1	7.4	5,000	500
	50		600	2.87	3.23	6.47	2.57	9.27	1.59	3.27	310	296	283	208	334	9.6	8.8	5,000	500
	60		250	2.39	2.23	3.72	1.48	5.33	1.26	1.36	164	156	150	110	192	5.0	4.5	6,000	600
	60		300	2.87	1.90	3.17	1.51	5.45	1.34	1.63	186	177	170	125	197	5.2	4.6	6,000	600
	60		400	2.87	2.38	3.96	1.89	6.82	1.50	2.18	230	220	210	155	246	6.7	6.0	6,000	600
	60		500	2.87	2.86	4.76	2.27	8.19	1.66	2.72	274	262	250	184	295	8.2	7.5	6,000	600
	60		600	2.87	3.33	5.56	2.65	9.56	1.82	3.27	319	304	291	214	345	9.7	8.9	6,000	600
	70		150	1.91	2.60	3.71	1.38	4.96	1.24	0.82	174	167	170	123	179	4.3	3.9	7,000	700
	70		200	2.39	1.98	2.83	1.31	4.74	1.33	1.09	169	161	154	113	171	4.3	3.7	7,000	700
	70		300	2.39	2.66	3.80	1.76	6.35	1.51	1.63	222	212	202	149	229	5.9	5.3	7,000	700
	70		400	2.87	2.46	3.52	1.96	7.06	1.69	2.18	238	227	217	160	255	6.8	6.1	7,000	700
	70		500	2.87	2.95	4.21	2.34	8.45	1.86	2.72	283	270	258	190	305	8.3	7.5	7,000	700
	80		150	1.91	2.70	3.38	1.43	5.17	1.37	0.82	191	182	174	128	186	4.4	4.0	8,000	800
	80		200	2.39	2.07	2.58	1.37	4.94	1.47	1.09	176	168	161	119	178	4.3	3.8	8,000	800
	80		300	2.39	2.75	3.44	1.82	6.57	1.67	1.63	230	219	210	154	237	6.0	5.4	8,000	800
	80		400	2.87	2.54	3.18	2.02	7.29	1.86	2.18	246	235	224	165	263	6.9	6.2	8,000	800
	80		500	2.87	3.03	3.79	2.41	8.69	2.06	2.72	291	277	265	195	313	8.4	7.6	8,000	800
	20		100	1.91	0.60	2.98	0.32	1.14	0.23	0.21	77	74	70	52	41	2.3	1.5	2,000	200
	20		150	2.39	0.49	2.47	0.33	1.18	0.23	0.32	93	88	85	62	43	2.9	1.9	2,000	200
	20		200	2.39	0.61	3.07	0.41	1.47	0.24	0.42	117	111	107	78	53	3.7	2.5	2,000	200
	20		300	2.87	0.63	3.13	0.50	1.79	0.24	0.63	156	149	143	105	65	5.1	3.5	2,000	200

Growing Rams

Age = 4 months
Maturity = 0.3
(late maturing)

30	1.91	1.09	3.63	0.58	2.08	0.33	0.42	1.39	1.33	1.27	93	75	4.1	3.0	3,000	300
30	2.39	0.79	2.62	0.52	1.88	0.33	0.53	1.47	1.40	1.34	98	68	4.5	3.2	3,000	300
30	2.39	0.91	3.02	0.60	2.17	0.34	0.63	1.71	1.63	1.56	115	78	5.3	3.8	3,000	300
30	2.39	1.15	3.82	0.76	2.74	0.35	0.84	2.19	2.09	2.00	147	99	6.9	5.0	3,000	300
40	1.91	1.37	3.42	0.73	2.62	0.43	0.53	1.73	1.65	1.58	116	94	5.1	3.7	4,000	400
40	2.39	1.58	3.96	0.84	3.03	0.44	0.63	2.01	1.92	1.83	135	109	6.0	4.5	4,000	400
40	2.39	1.20	3.00	0.80	2.87	0.43	0.84	2.25	2.15	2.05	151	103	7.0	5.1	4,000	400
40	2.39	1.44	3.60	0.96	3.45	0.45	1.05	2.73	2.61	2.49	184	124	8.6	6.3	4,000	400
50	1.91	1.43	2.87	0.76	2.74	0.50	0.53	1.79	1.71	1.63	120	99	5.1	3.8	5,000	500
50	1.91	1.65	3.30	0.87	3.15	0.52	0.63	2.07	1.98	1.89	139	114	6.0	4.5	5,000	500
50	2.39	1.25	2.50	0.83	2.99	0.51	0.84	2.30	2.20	2.10	155	108	7.0	5.1	5,000	500
50	2.39	1.50	2.99	0.99	3.57	0.54	1.05	2.79	2.66	2.55	187	129	8.7	6.4	5,000	500
50	2.39	1.74	3.48	1.15	4.16	0.56	1.26	3.27	3.12	2.99	220	150	10.3	7.6	5,000	500
60	1.91	1.49	2.49	0.79	2.85	0.58	0.53	1.85	1.76	1.69	124	103	5.2	3.9	6,000	600
60	1.91	1.71	2.85	0.91	3.27	0.60	0.63	2.13	2.03	1.94	143	118	6.1	4.6	6,000	600
60	1.91	2.15	3.58	1.14	4.11	0.63	0.84	2.69	2.57	2.46	181	148	7.9	6.0	6,000	600
60	2.39	1.55	2.58	1.02	3.70	0.61	1.05	2.84	2.71	2.60	191	133	8.7	6.4	6,000	600
60	2.39	1.79	2.99	1.19	4.28	0.64	1.26	3.33	3.18	3.04	224	154	10.3	7.7	6,000	600
70	1.91	1.11	1.59	0.59	2.12	0.61	0.32	1.34	1.28	1.22	90	76	3.4	2.5	7,000	700
70	1.91	1.33	1.90	0.71	2.54	0.63	0.42	1.62	1.55	1.48	109	92	4.3	3.2	7,000	700
70	1.91	1.77	2.53	0.94	3.39	0.67	0.63	2.19	2.09	2.00	147	122	6.1	4.6	7,000	700
70	1.91	2.21	3.16	1.17	4.23	0.75	1.05	3.31	3.16	3.03	223	183	9.7	7.5	7,000	700
80	1.91	2.65	3.79	1.41	5.07	0.75	1.32	4.40	4.25	4.13	303	243	13.5	10.0	8,000	800
80	1.91	1.16	1.45	0.62	2.22	0.67	0.32	1.40	1.33	1.27	94	80	3.5	2.5	8,000	800
80	1.91	1.38	1.73	0.73	2.65	0.70	0.42	1.68	1.60	1.53	113	95	4.4	3.3	8,000	800
80	1.91	1.83	2.28	0.97	3.49	0.74	0.63	2.24	2.14	2.05	151	126	6.2	4.7	8,000	800
80	1.91	2.27	2.84	1.20	4.34	0.78	0.84	2.81	2.68	2.56	189	157	8.0	6.1	8,000	800
80	1.91	2.72	3.39	1.44	5.19	0.83	1.05	3.37	3.22	3.08	227	187	9.8	7.6	8,000	800
20	2.39	0.65	3.27	0.43	1.56	0.24	0.46	71	67	65	47	56	2.1	1.5	2,000	200
150	2.87	0.67	3.34	0.53	1.92	0.25	0.68	85	81	78	57	69	2.7	2.0	2,000	200
200	2.87	0.85	4.26	0.68	2.44	0.26	0.91	107	102	98	72	88	3.4	2.7	2,000	200
300	2.87	1.22	6.10	0.97	3.50	0.28	1.37	150	143	137	101	126	4.9	4.0	2,000	200
200	2.87	0.90	3.00	0.72	2.58	0.35	0.91	113	108	103	76	93	3.5	2.7	3,000	300
250	2.87	1.09	3.62	0.86	3.12	0.36	1.14	135	128	123	90	112	4.2	3.4	3,000	300
300	2.87	1.27	4.24	1.01	3.65	0.37	1.37	156	149	143	105	132	4.9	4.1	3,000	300
400	2.87	1.64	5.48	1.31	4.71	0.40	1.83	200	191	182	134	170	6.4	5.4	3,000	300
250	2.39	1.54	3.86	1.02	3.69	0.46	1.14	157	150	144	106	133	4.6	3.8	4,000	400
300	2.87	1.32	3.30	1.05	3.79	0.46	1.37	162	155	148	109	137	5.0	4.1	4,000	400
400	2.87	1.70	4.24	1.35	4.86	0.50	1.83	206	196	188	138	175	6.5	5.4	4,000	400
500	2.87	2.07	5.18	1.65	5.94	0.53	2.28	249	238	228	168	214	8.0	6.8	4,000	400
250	2.39	1.60	3.20	1.06	3.82	0.54	1.14	164	156	149	110	138	4.7	3.9	5,000	500
300	2.39	1.86	3.72	1.23	4.45	0.57	1.37	189	180	172	127	160	5.5	4.6	5,000	500
400	2.87	1.74	3.49	1.39	5.00	0.59	1.83	212	202	193	142	180	6.5	5.5	5,000	500
500	2.87	2.12	4.25	1.69	6.09	0.63	2.28	255	244	233	172	219	8.0	6.8	5,000	500
600	2.87	2.50	5.00	1.99	7.17	0.67	2.74	299	286	273	201	259	9.5	8.1	5,000	500
250	2.39	1.65	2.75	1.09	3.94	0.62	1.14	170	162	155	114	142	4.7	3.9	6,000	600
300	2.39	1.92	3.19	1.27	4.58	0.65	1.37	195	186	178	131	165	5.5	4.7	6,000	600
400	2.87	1.79	2.99	1.42	5.14	0.67	1.83	218	208	199	146	185	6.6	5.5	6,000	600
500	2.87	2.17	3.62	1.73	6.23	0.72	2.28	261	250	239	176	225	8.1	6.9	6,000	600

Age = 4 months
Maturity = 0.6
(early maturing)

TABLE 15-2 continued

Class/Age/Other	Body Weight ^a kg	Weight or Milk Yield ^b kg	Body Weight Gain ^{c,d} g/d	Energy Concentration in Diet ^e kcal/kg	Daily Dry Matter Intake ^f		Energy Requirements ^g				Protein Requirements ^h				Mineral Requirements ⁱ		Vitamin Requirements ^j		
					kg	% BW	TDN kg/d	ME kcal/d	NEEm kcal/d	NEg kcal/d	CP @20% UIP g/d	CP @40% UIP g/d	CP @60% UIP g/d	MP g/d	DIP g/d	Ca g/d	P g/d	A RE/d	E IU/d
60	600		600	2.87	2.55	4.26	2.03	7.32	0.76	2.74	305	292	279	205	264	9.5	8.2	6,000	600
70	150		150	1.91	1.88	2.69	1.00	3.60	0.68	0.68	155	148	142	104	130	3.8	3.2	7,000	700
70	200		200	1.91	2.36	3.37	1.25	4.51	0.72	0.91	190	181	173	127	163	4.8	4.1	7,000	700
70	300		300	2.39	1.97	2.81	1.30	4.70	0.73	1.37	201	192	183	135	170	5.6	4.7	7,000	700
70	400		400	2.39	2.50	3.58	1.66	5.98	0.79	1.83	251	240	229	169	216	7.2	6.2	7,000	700
70	500		500	2.87	2.22	3.17	1.77	6.37	0.81	2.28	267	255	244	180	230	8.1	6.9	7,000	700
80	150		150	1.91	1.94	2.43	1.03	3.71	0.75	0.68	161	154	147	108	134	3.8	3.2	8,000	800
80	200		200	1.91	2.42	3.03	1.28	4.63	0.80	0.91	196	187	179	132	167	4.8	4.2	8,000	800
80	300		300	2.39	2.02	2.52	1.34	4.82	0.81	1.37	206	197	189	139	174	5.6	4.8	8,000	800
80	400		400	2.39	2.56	3.20	1.70	6.11	0.87	1.83	257	246	235	173	220	7.3	6.3	8,000	800
80	500		500	2.39	3.10	3.87	2.05	7.40	0.94	2.28	308	294	281	207	267	8.9	7.8	8,000	800
20	100		100	2.39	0.63	3.14	0.42	1.50	0.47	0.30	75	71	68	50	54	2.2	1.5	2,000	200
20	150		150	2.39	0.80	4.00	0.53	1.91	0.48	0.45	99	94	90	66	69	3.0	2.2	2,000	200
20	200		200	2.87	0.73	3.65	0.58	2.09	0.49	0.59	113	108	104	76	75	3.6	2.6	2,000	200
20	300		300	2.87	0.98	4.88	0.88	2.80	0.52	0.89	158	150	144	106	101	5.1	3.8	2,000	200
30	200		200	2.39	1.09	3.62	0.72	2.60	0.68	0.59	131	125	120	88	94	3.9	2.9	3,000	300
30	250		250	2.87	0.95	3.17	0.76	2.72	0.68	0.74	143	137	131	96	98	4.4	3.3	3,000	300
30	300		300	2.87	1.08	3.59	0.86	3.08	0.70	0.89	166	158	151	111	111	5.2	3.9	3,000	300
30	400		400	2.87	1.33	4.42	1.06	3.81	0.74	1.19	210	200	192	141	137	6.7	5.2	3,000	300
40	250		250	2.39	1.37	3.43	0.91	3.28	0.87	0.74	164	156	149	110	118	4.8	3.7	4,000	400
40	300		300	2.39	1.55	3.88	1.03	3.71	0.89	0.89	188	179	172	126	134	5.6	4.4	4,000	400
40	400		400	2.87	1.42	3.56	1.13	4.08	0.91	1.19	218	208	199	146	147	6.8	5.2	4,000	400
40	500		500	2.87	1.68	4.20	1.34	4.81	0.96	1.48	262	250	239	176	174	8.3	6.5	4,000	400
50	250		250	2.39	1.47	2.95	0.98	3.52	1.02	0.74	171	164	157	115	127	4.9	3.8	5,000	500
50	300		300	2.39	1.66	3.31	1.10	3.96	1.05	0.89	196	187	179	132	143	5.7	4.5	5,000	500
50	400		400	2.87	1.51	3.03	1.20	4.34	1.08	1.19	225	215	206	151	156	6.9	5.3	5,000	500
50	500		500	2.87	1.77	3.55	1.41	5.09	1.13	1.48	270	258	247	181	183	8.4	6.6	5,000	500
60	600		600	2.87	2.03	4.07	1.62	5.83	1.18	1.78	315	300	287	212	210	9.9	7.8	5,000	500
60	250		250	2.39	1.57	2.62	1.04	3.76	1.17	0.74	179	171	164	120	135	5.0	3.9	6,000	600
60	300		300	2.39	1.76	2.93	1.16	4.20	1.21	0.89	204	194	186	137	151	5.8	4.6	6,000	600
60	400		400	2.39	2.13	3.54	1.41	5.08	1.28	1.19	253	241	231	170	183	7.4	5.9	6,000	600
60	500		500	2.87	1.86	3.11	1.48	5.34	1.30	1.48	278	265	253	187	193	8.5	6.7	6,000	600
60	600		600	2.87	2.13	3.55	1.69	6.10	1.36	1.78	323	308	294	217	220	10.0	7.9	6,000	600
70	150		150	1.91	1.91	2.73	1.01	3.66	1.29	0.45	161	154	147	108	132	4.0	3.2	7,000	700
70	200		200	1.91	2.25	3.21	1.19	4.29	1.34	0.59	192	183	175	129	155	5.0	4.1	7,000	700
70	300		300	2.39	1.85	2.65	1.23	4.43	1.36	0.89	211	202	193	142	160	5.9	4.7	7,000	700
70	400		400	2.39	2.23	3.18	1.48	5.32	1.43	1.19	261	249	238	175	192	7.5	6.0	7,000	700
70	500		500	2.39	2.60	3.72	1.72	6.22	1.51	1.48	310	296	283	208	224	9.1	7.4	7,000	700
80	150		150	1.91	2.02	2.53	1.07	3.87	1.42	0.45	169	161	154	114	139	4.1	3.3	8,000	800
80	200		200	1.91	2.36	2.95	1.25	4.51	1.49	0.59	200	191	182	134	163	5.1	4.2	8,000	800
80	300		300	1.91	3.04	3.80	1.61	5.81	1.61	0.89	261	249	239	176	209	7.0	5.8	8,000	800
80	400		400	2.39	2.33	2.91	1.54	5.56	1.58	1.19	268	256	245	180	200	7.6	6.1	8,000	800
80	500		500	2.39	2.71	3.38	1.79	6.47	1.67	1.48	318	303	290	214	233	9.2	7.5	8,000	800

Age = 8 months
Maturity = 0.4
(late maturing)

20	2.87	0.69	3.44	0.55	1.98	0.49	0.54	70	67	64	71	2.0	1.5	2,000	200
150	2.87	0.91	4.57	0.73	2.62	0.82	0.82	91	87	83	95	2.8	2.2	2,000	200
200	2.87	1.14	5.70	0.91	3.27	0.53	1.09	113	108	103	118	3.5	2.9	2,000	200
300	2.87	1.59	7.96	1.27	4.57	0.58	1.63	156	149	142	165	5.0	4.3	2,000	200
200	2.87	1.24	4.14	0.99	3.57	0.72	1.09	122	116	111	132	3.6	3.0	3,000	300
250	2.87	1.47	4.91	1.17	4.23	0.76	1.36	143	137	131	152	4.3	3.7	3,000	300
300	2.87	1.70	5.68	1.36	4.89	0.79	1.63	165	158	151	176	5.1	4.4	3,000	300
400	2.87	2.16	7.22	1.72	6.21	0.85	2.18	208	199	190	224	6.5	5.8	3,000	300
250	2.87	1.57	3.93	1.25	4.51	0.94	1.36	152	145	139	163	4.4	3.8	4,000	400
300	2.87	1.81	4.52	1.44	5.18	0.98	1.63	174	166	159	187	5.2	4.5	4,000	400
400	2.87	2.28	5.69	1.81	6.53	1.06	2.18	218	208	199	235	6.6	5.9	4,000	400
500	2.87	2.75	6.86	2.18	7.87	1.14	2.72	262	250	239	284	8.1	7.4	4,000	400
250	2.87	1.66	3.33	1.32	4.78	1.11	1.36	161	153	147	172	4.5	3.9	5,000	500
300	2.87	1.90	3.81	1.51	5.46	1.16	1.63	183	174	167	197	5.2	4.6	5,000	500
400	2.87	2.38	4.76	1.89	6.83	1.25	2.18	227	217	207	246	6.7	6.0	5,000	500
500	2.87	2.86	5.72	2.27	8.20	1.35	2.72	271	259	248	296	8.2	7.5	5,000	500
600	2.87	3.34	6.67	2.65	9.57	1.45	3.27	315	301	288	345	9.7	8.9	5,000	500
250	2.39	2.34	3.90	1.55	5.60	1.32	1.36	169	161	154	202	5.1	4.6	6,000	600
300	2.87	2.00	3.33	1.59	5.72	1.33	1.63	191	182	175	226	5.3	4.7	6,000	600
400	2.87	2.48	4.13	1.97	7.11	1.44	2.18	236	225	215	256	6.8	6.1	6,000	600
500	2.87	2.97	4.94	2.36	8.50	1.55	2.72	280	268	256	307	8.3	7.6	6,000	600
600	2.87	3.45	5.75	2.74	9.90	1.66	3.27	325	310	297	357	9.8	9.0	6,000	600
150	1.91	2.75	3.92	1.46	5.25	1.43	0.82	190	181	173	218	4.4	4.0	7,000	700
200	2.39	2.10	3.00	1.39	5.02	1.41	1.09	175	167	160	181	4.4	3.9	7,000	700
300	2.39	2.79	3.98	1.85	6.67	1.55	1.63	228	218	209	240	6.1	5.5	7,000	700
400	2.87	2.58	3.68	2.05	7.39	1.61	2.18	244	233	223	266	6.9	6.2	7,000	700
500	2.87	3.07	4.38	2.44	8.80	1.74	2.72	289	276	264	317	8.4	7.7	7,000	700
150	1.91	2.87	3.59	1.52	5.49	1.58	0.82	199	190	182	198	4.5	4.1	8,000	800
200	2.39	2.20	2.75	1.46	5.26	1.56	1.09	183	175	167	189	4.5	3.9	8,000	800
300	2.39	2.90	3.62	1.92	6.92	1.71	1.63	237	226	217	249	6.2	5.6	8,000	800
400	2.87	2.67	3.33	2.12	7.65	1.78	2.18	253	241	231	276	7.0	6.3	8,000	800
500	2.87	3.17	3.96	2.52	9.08	1.92	2.72	298	285	272	327	8.5	7.8	8,000	800

Yearling Farm Ewes
Maintenance plus growth

40	2.39	1.18	2.94	0.78	2.81	1.43	0.23	97	93	89	101	3.1	1.7	2,140	224
50	2.39	1.43	2.85	0.95	3.41	1.72	0.29	117	112	107	123	3.7	2.1	2,675	280
60	2.39	1.67	2.78	1.11	3.99	2.00	0.34	137	131	125	144	4.2	2.5	3,210	336
70	2.39	1.91	2.73	1.27	4.56	2.27	0.40	156	149	143	165	4.8	2.9	3,745	392
80	2.39	2.15	2.68	1.42	5.13	2.54	0.46	176	168	161	185	5.3	3.3	4,280	448
90	2.39	2.38	2.64	1.58	5.68	2.80	0.51	195	186	178	205	5.9	3.7	4,815	504
100	2.39	2.61	2.61	1.73	6.23	3.05	0.57	214	204	195	225	6.4	4.1	5,350	560
120	2.39	3.06	2.55	2.03	7.31	3.56	0.68	252	240	230	263	7.4	4.8	6,420	672

Breeding

40	2.39	1.28	3.20	0.85	3.06	1.59	0.23	110	105	100	110	3.6	2.1	2,140	224
50	2.39	1.55	3.10	1.03	3.70	1.91	0.29	132	126	121	133	4.3	2.5	2,675	280
60	2.39	1.81	3.02	1.20	4.33	2.22	0.34	154	147	141	156	4.9	3.0	3,210	336
70	2.39	2.07	2.96	1.37	4.95	2.52	0.40	176	168	161	178	5.6	3.4	3,745	392
80	2.39	2.32	2.91	1.54	5.56	2.81	0.46	198	189	181	200	6.2	3.9	4,280	448
90	2.39	2.58	2.86	1.71	6.15	3.10	0.51	219	209	200	222	6.8	4.4	4,815	504

TABLE 15-2 continued

Class/Age/Other	Body Weight ^a kg	Weight or Milk Yield ^b kg	Body Weight Gain ^{c,d} g/d	Energy Concentration in Diet ^e kcal/kg	Daily Dry Matter Intake ^f kg	% BW	Energy Requirements ^g			Protein Requirements ^h			Mineral Requirements ⁱ		Vitamin Requirements ^j					
							TDN kg/d	ME kcal/d	NE _m kcal/d	CP @20% UIP g/d	CP @40% UIP g/d	CP @60% UIP g/d	DIP g/d	Ca g/d	P g/d	RE/d	A IU/d	E IU/d		
	100	143	2.39	2.39	2.82	2.82	1.87	6.75	3.39	0.57	241	230	220	162	243	7.5	4.8	5,350	560	
	120	170	2.39	2.39	3.31	2.76	2.19	7.91	3.94	0.68	283	270	258	190	285	8.7	5.7	6,420	672	
Early gestation (Single lamb; BW = 3.5 to 6.3 kg)																				
	40	3.5	58	2.39	1.33	3.33	0.88	3.19	1.43	0.23	116	111	106	78	115	4.4	2.8	1,256	212	
	50	3.9	71	2.39	1.60	3.20	1.06	3.83	1.72	0.29	138	132	126	93	138	5.1	3.3	1,570	265	
	60	4.3	84	2.39	1.86	3.11	1.24	4.45	2.00	0.34	160	153	146	108	161	5.8	3.8	1,884	318	
	70	4.7	97	2.39	2.12	3.03	1.41	5.07	2.27	0.40	182	174	166	122	183	6.5	4.3	2,198	371	
	80	5.0	110	2.39	2.37	2.96	1.57	5.66	2.54	0.46	203	194	185	136	204	7.1	4.8	2,512	424	
	90	5.4	123	2.39	2.62	2.91	1.74	6.26	2.80	0.51	224	214	205	151	226	7.8	5.3	2,826	477	
	100	5.7	135	2.39	2.86	2.86	1.90	6.84	3.06	0.57	245	234	223	164	247	8.4	5.8	3,140	530	
	120	6.3	161	2.39	3.34	2.78	2.21	7.99	3.57	0.68	286	273	261	192	288	9.6	6.8	3,768	636	
Early gestation (Twin lambs; BW = 3.1 to 5.5 kg)																				
	40	3.1	70	2.87	1.15	2.88	0.91	3.30	1.37	0.23	120	114	109	81	119	5.5	3.2	1,256	212	
	50	3.4	85	2.39	1.73	3.46	1.15	4.13	1.72	0.29	155	148	141	104	149	6.7	4.1	1,570	265	
	60	3.8	100	2.39	2.01	3.35	1.33	4.80	2.00	0.34	179	171	163	120	173	7.6	4.8	1,884	318	
	70	4.1	146	2.39	2.28	3.25	1.51	5.44	2.27	0.40	202	192	184	135	196	8.9	5.7	2,198	371	
	80	4.4	110	2.39	2.54	3.17	1.68	6.06	2.54	0.46	224	214	205	151	219	9.0	5.7	2,512	424	
	90	4.7	123	2.39	2.80	3.11	1.85	6.68	2.80	0.51	247	235	225	166	241	9.7	6.3	2,826	477	
	100	5.0	135	2.39	3.05	3.05	2.02	7.30	3.06	0.57	269	257	246	181	263	10.5	6.8	3,140	530	
	120	5.5	161	2.39	3.55	2.96	2.35	8.48	3.57	0.68	312	298	285	210	306	11.9	7.9	3,768	636	
Early gestation (Three lambs; BW = 2.6 to 4.7 kg)																				
	40	2.6	79	2.87	1.21	3.02	0.96	3.47	1.37	0.23	128	123	117	86	125	6.4	3.6	1,256	212	
	50	2.9	96	2.87	1.44	2.87	1.14	4.12	1.65	0.29	151	144	138	101	148	7.3	4.3	1,570	265	
	60	3.2	112	2.39	2.10	3.50	1.39	5.01	2.00	0.34	190	181	174	128	181	8.8	5.4	1,884	318	
	70	3.5	129	2.39	2.38	3.40	1.58	5.68	2.27	0.40	215	205	196	144	205	9.8	6.1	2,198	371	
	80	3.8	145	2.39	2.65	3.32	1.76	6.34	2.54	0.46	239	228	218	160	229	10.7	6.7	2,512	424	
	90	4.0	161	2.39	2.91	3.23	1.93	6.96	2.80	0.51	261	249	239	176	251	11.5	7.3	2,826	477	
	100	4.3	177	2.39	3.18	3.18	2.11	7.60	3.06	0.57	285	272	260	192	274	12.5	8.0	3,140	530	
	120	4.7	208	2.39	3.69	3.07	2.44	8.81	3.57	0.68	329	314	301	221	318	14.1	9.2	3,768	636	
Late gestation (Single lamb; BW = 3.5 to 6.3 kg)																				
	40	3.5	111	2.87	1.20	3.01	0.96	3.45	1.37	0.23	128	122	117	86	124	5.8	3.4	1,820	224	
	50	3.9	134	2.87	1.43	2.86	1.14	4.10	1.65	0.29	150	143	137	101	148	6.7	4.0	2,275	280	
	60	4.3	157	2.39	2.09	3.48	1.38	4.99	2.00	0.34	189	181	173	127	180	8.1	5.1	2,730	336	
	70	4.7	179	2.39	2.37	3.38	1.57	5.65	2.27	0.40	214	204	195	144	204	9.0	5.8	3,185	392	
	80	5.0	200	2.39	2.63	3.29	1.74	6.29	2.54	0.46	237	226	216	159	227	9.8	6.4	3,640	448	
	90	5.4	221	2.39	2.90	3.22	1.92	6.93	2.80	0.51	261	249	238	175	250	10.7	7.0	4,095	504	
	100	5.7	242	2.39	3.16	3.16	2.09	7.55	3.06	0.57	283	270	259	190	272	11.6	7.6	4,550	560	
	120	6.3	283	2.39	3.67	3.06	2.43	8.77	3.56	0.68	328	313	300	221	316	13.2	8.8	5,460	672	

TABLE 15-2 continued

Class/Age/Other	Body Weight ^e kg	Weight or Milk Yield ^b kg	Body Weight Gain ^{a,d} g/d	Energy Concentration in Diet ^f kcal/kg	Daily Dry Matter Intake ^f kg	Energy Requirements ^f			Protein Requirements ^g			Mineral Requirements ^h		Vitamin Requirements ⁱ					
						TDN kg/d	ME Mcal/d	NEEm Mcal/d	NEg Mcal/d	CP @20% UIP g/d	CP @40% UIP g/d	CP @60% UIP g/d	DIP g/d	Ca g/d	P g/d	A RE/d	E IU/d		
Early gestation (Twin lambs; BW = 3.1 to 5.5 kg)																			
40	3.1	70	2.87	2.87	1.14	2.84	0.90	3.26	1.35	0.23	120	115	110	81	117	5.5	3.2	1,256	212
50	3.4	85	2.39	2.39	1.71	3.42	1.13	4.08	1.69	0.29	156	148	142	104	147	6.7	4.1	1,570	265
60	3.8	100	2.39	2.39	1.99	3.31	1.32	4.75	1.96	0.34	180	172	164	121	171	7.6	4.7	1,884	318
70	4.1	115	2.39	2.39	2.25	3.21	1.49	5.37	2.23	0.40	203	194	185	136	194	8.4	5.3	2,198	371
80	4.4	130	2.39	2.39	2.51	3.14	1.66	5.99	2.50	0.46	226	215	206	152	216	9.1	5.9	2,512	424
90	4.7	145	2.39	2.39	2.76	3.07	1.83	6.61	2.75	0.51	248	237	227	167	238	9.9	6.5	2,826	477
100	5.0	159	2.39	2.39	3.02	3.02	2.00	7.21	3.01	0.57	271	258	247	182	260	10.7	7.1	3,140	530
120	5.5	188	2.39	2.39	3.51	2.92	2.33	8.39	3.50	0.68	314	300	287	211	302	12.1	8.1	3,768	636
Early gestation (Three lambs; BW = 2.6 to 4.7 kg)																			
40	2.6	79	2.87	2.87	1.19	2.99	0.95	3.43	1.35	0.23	129	123	118	87	124	6.4	3.6	1,256	212
50	2.9	96	2.87	2.87	1.42	2.84	1.13	4.07	1.62	0.29	152	145	139	102	147	7.3	4.2	1,570	265
60	3.2	112	2.39	2.39	2.07	3.46	1.37	4.96	1.96	0.34	191	182	174	128	179	8.7	5.4	1,884	318
70	3.5	129	2.39	2.39	2.35	3.36	1.56	5.62	2.23	0.40	216	206	197	145	203	9.7	6.0	2,198	371
80	3.8	145	2.39	2.39	2.62	3.28	1.74	6.27	2.50	0.46	240	229	219	161	226	10.6	6.7	2,512	424
90	4.0	161	2.39	2.39	2.88	3.20	1.91	6.88	2.75	0.51	263	251	240	177	248	11.4	7.3	2,826	477
100	4.3	177	2.39	2.39	3.15	3.15	2.08	7.52	3.01	0.57	287	274	262	193	271	12.3	7.9	3,140	530
120	4.7	208	2.39	2.39	3.65	3.04	2.42	8.71	3.50	0.68	331	316	303	223	314	13.9	9.1	3,768	636
Late gestation (Single lamb; BW = 3.5 to 6.3 kg)																			
40	3.5	111	2.87	2.87	1.19	2.97	0.94	3.41	1.34	0.23	128	122	116	86	123	5.8	3.3	1,820	224
50	3.9	134	2.87	2.87	1.41	2.82	1.12	4.04	1.61	0.29	150	143	137	101	146	6.6	4.0	2,275	280
60	4.3	157	2.39	2.39	2.06	3.44	1.37	4.93	1.96	0.34	189	180	173	127	178	8.0	5.1	2,730	336
70	4.7	179	2.39	2.39	2.34	3.34	1.55	5.59	2.23	0.40	213	204	195	143	201	8.9	5.7	3,185	392
80	5.0	200	2.39	2.39	2.60	3.25	1.72	6.21	2.49	0.46	236	226	216	159	224	9.7	6.3	3,640	448
90	5.4	221	2.39	2.39	2.87	3.19	1.90	6.85	2.75	0.51	261	249	238	175	247	10.6	7.0	4,095	504
100	5.7	242	2.39	2.39	3.12	3.12	2.07	7.46	3.00	0.57	283	270	259	190	269	11.4	7.6	4,550	560
120	6.3	283	2.39	2.39	3.63	3.02	2.40	8.67	3.50	0.68	328	313	300	221	312	13.0	8.8	5,460	672
Late gestation (Twin lambs; BW = 3.1 to 5.5 kg)																			
40	3.1	159	2.87	2.87	1.40	3.51	1.12	4.03	1.34	0.23	159	151	145	107	145	8.5	4.8	1,820	224
50	3.4	191	2.87	2.87	1.64	3.29	1.31	4.71	1.61	0.29	183	175	167	123	170	9.6	5.5	2,275	280
60	3.8	221	2.87	2.87	1.89	3.16	1.51	5.43	1.87	0.34	210	201	192	141	196	10.9	6.4	2,730	336
70	4.1	251	2.87	2.87	2.12	3.03	1.69	6.09	2.13	0.40	235	224	214	158	219	11.9	7.1	3,185	392
80	4.4	280	2.87	2.87	2.35	2.94	1.87	6.74	2.37	0.46	259	247	236	174	243	13.0	7.8	3,640	448
90	4.7	308	2.87	2.87	2.57	2.86	2.05	7.38	2.62	0.51	283	270	258	190	266	14.1	8.6	4,095	504
100	5.0	336	2.87	2.87	2.80	2.80	2.22	8.02	2.85	0.57	307	293	280	206	289	15.1	9.3	4,550	560
120	5.5	391	2.39	2.39	4.08	3.40	2.70	9.75	3.50	0.68	385	367	351	259	352	18.1	11.6	5,460	672

Late gestation (Three lambs; BW = 2.6 to 4.7 kg)																		
40	2.6	195	2.87	1.53	3.83	1.22	4.40	1.34	0.23	177	169	162	119	159	10.2	5.7	1,820	224
50	2.9	233	2.87	1.80	3.59	1.43	5.15	1.61	0.29	205	196	187	138	186	11.6	6.6	2,275	280
60	3.2	270	2.87	2.05	3.42	1.63	5.89	1.87	0.34	233	223	213	157	212	13.0	7.6	2,730	336
70	3.5	305	2.87	2.31	3.30	1.84	6.62	2.13	0.40	261	249	238	175	239	14.4	8.5	3,185	392
80	3.8	340	2.87	2.56	3.20	2.04	7.34	2.37	0.46	289	275	263	194	265	15.8	9.4	3,640	448
90	4.0	374	2.87	2.78	3.09	2.21	7.98	2.62	0.51	313	298	285	210	288	17.0	10.1	4,095	504
100	4.3	407	2.87	3.03	3.03	2.41	8.69	2.85	0.57	340	324	310	228	313	18.3	11.0	4,550	560
120	4.7	472	2.87	3.47	2.89	2.76	9.94	3.32	0.68	387	370	354	260	359	20.5	12.5	5,460	672

Lactation; early, mid-, and late lactation for yearlings in range flocks nursing 1, 2, or 3 lambs are in Table 15-1.

^aBody weight used in estimating requirements is the determined or estimated weight in kilograms (kg) average for the period during which these requirements will be applied.

^bBirth weight (kg) of single and average of multiple lambs or liquid milk yield (kg/d).

^cAverage change in body weight over a 24-hour period.

^dBody weight change in yearling ewes includes both weight gain associated with growth toward maturity and weight change related to breeding, pregnancy, and lactation.

^eThree hypothetical diets with increasing energy concentrations (1.91, 2.34, and 2.87 kcal/kg) were used in the calculations of intake and nutrient requirements. For each line entry, a diet was selected to represent the level of energy concentration that approximates that needed by the animal to achieve adequate intake to satisfy its energy requirement.

^fThe daily dry matter intake, expressed as kg or as percentage of body weight, of a diet having the indicated energy concentration (previous column) that is required to meet energy requirements. These energy concentrations should be viewed only as examples. In some cases, diets having greater or lesser concentrations of energy would be more appropriate.

^gEnergy requirements expressed as total digestible nutrients (TDN) in kg/d and metabolizable energy (ME), net energy for maintenance (NE_m), and net energy for gain (NE_g) as kcal/d.

^hProtein requirements expressed as crude protein (CP), metabolizable protein (MP), and degradable intake protein (DIP). The CP requirement differs with the proportion of undegradable intake protein (UIP) because of the required minimal DIP.

ⁱTwo macro minerals, calcium (Ca) and phosphorus (P), commonly considered in balancing diets are included. Often, the balance (ratio) of the two minerals also is of concern.

^jTwo fat-soluble vitamins, A and E, that often are deficient in animal diets are expressed as retinol equivalents (RE) and international units (IU) for vitamins A and E, respectively. RE = 1.0 µg of all-trans retinol, 5.0 µg of all-trans beta-carotene, and 7.6 µg of other carotenoids.

TABLE 15-3 Mineral Requirements of Sheep^a

Class/Stage/Other	Body Weight ^b kg	Body Weight Gain ^c g/d	Dry Matter Intake ^d kg/d	Na g/d	Cl g/d	K g/d	Mg g/d	S g/d	Co mg/d	Cu ^e mg/d	I mg/d	Fe mg/d	Mn mg/d	Se ^f mg/d	Se ^g mg/d	Zn ^h mg/d
Growing Lambs and Yearlings (Rams, ewes, castrates)																
	20	100	0.63	0.4	0.3	2.9	0.6	1.1	0.13	3.1	0.3	32	12	0.09	0.18	13
	20	150	0.74	0.4	0.3	3.3	0.7	1.3	0.15	4.0	0.4	46	15	0.13	0.27	17
	20	200	0.82	0.5	0.4	3.6	0.8	1.5	0.16	4.9	0.4	61	18	0.18	0.35	21
	20	300	1.09	0.6	0.5	4.6	1.1	2.0	0.22	6.6	0.5	90	24	0.26	0.52	29
	30	200	1.10	0.6	0.5	4.8	1.0	2.0	0.22	5.5	0.5	62	21	0.18	0.36	24
	30	250	1.05	0.7	0.5	4.8	1.1	1.9	0.21	6.4	0.5	77	24	0.22	0.44	28
	30	300	1.22	0.7	0.6	5.4	1.3	2.2	0.24	7.3	0.6	91	27	0.26	0.53	32
	30	400	1.55	0.8	0.7	6.5	1.5	2.8	0.31	9.1	0.8	120	33	0.35	0.69	40
	40	250	1.44	0.8	0.6	6.3	1.3	2.6	0.29	7.1	0.7	78	26	0.23	0.45	45
	40	300	1.54	0.8	0.7	6.7	1.4	2.8	0.31	8.0	0.8	92	29	0.27	0.53	51
	40	400	1.62	1.0	0.7	7.2	1.7	2.9	0.32	9.7	0.8	121	36	0.35	0.70	63
	40	500	1.96	1.1	0.8	8.3	1.9	3.5	0.39	11.5	1.0	150	42	0.43	0.87	75
	50	250	1.51	0.9	0.7	7.0	1.5	2.7	0.30	7.8	0.8	79	29	0.23	0.46	49
	50	300	1.73	1.0	0.7	7.7	1.6	3.1	0.35	8.6	0.9	94	32	0.27	0.54	55
	50	400	1.75	1.1	0.8	8.0	1.8	3.2	0.35	10.4	0.9	123	38	0.35	0.71	67
	50	500	2.03	1.2	0.9	9.0	2.1	3.7	0.41	12.2	1.0	152	45	0.44	0.88	79
	50	600	2.37	1.3	1.0	10.1	2.3	4.3	0.47	13.9	1.2	181	51	0.52	1.04	91
	60	250	1.83	1.0	0.8	8.3	1.7	3.3	0.37	8.4	0.9	81	32	0.23	0.47	53
	60	300	1.81	1.1	0.8	8.3	1.8	3.2	0.36	9.3	0.9	95	35	0.28	0.55	59
	60	400	2.18	1.2	0.9	9.6	2.0	3.9	0.44	11.1	1.1	124	41	0.36	0.72	71
	60	500	2.17	1.3	1.0	9.8	2.3	3.9	0.43	12.8	1.1	153	47	0.44	0.88	83
	60	600	2.44	1.4	1.1	10.8	2.5	4.4	0.49	14.6	1.2	182	54	0.53	1.05	95
	70	150	1.86	1.0	0.8	8.6	1.6	3.3	0.37	7.3	0.9	53	28	0.15	0.31	45
	70	200	1.96	1.1	0.8	9.0	1.7	3.5	0.39	8.2	1.0	68	31	0.20	0.39	51
	70	300	2.18	1.2	0.9	9.8	2.0	3.9	0.44	10.0	1.1	97	37	0.28	0.56	63
	70	400	2.33	1.3	1.0	10.5	2.2	4.2	0.47	11.7	1.2	126	44	0.36	0.73	75
	70	500	2.59	1.4	1.1	11.4	2.4	4.7	0.52	13.5	1.3	155	50	0.45	0.89	87
	80	150	1.94	1.1	0.9	9.3	1.8	3.5	0.39	8.0	1.0	55	31	0.16	0.32	48
	80	200	2.04	1.2	0.9	9.7	1.9	3.7	0.41	8.9	1.0	69	34	0.20	0.40	54
	80	300	2.39	1.3	1.0	10.9	2.1	4.3	0.48	10.6	1.2	98	40	0.28	0.57	66
	80	400	2.40	1.4	1.1	11.1	2.4	4.3	0.48	12.4	1.2	127	46	0.37	0.73	78
	80	500	2.87	1.6	1.2	12.7	2.6	5.2	0.57	14.2	1.4	156	53	0.45	0.90	90
Yearling Ewes (Farm and range flocks)																
Maintenance only																
	40	0	0.81	0.5	0.4	4.0	0.7	1.3	0.08	2.7	0.4	6	11	0.02	0.03	20
	60	0	1.10	0.7	0.6	5.7	1.1	1.8	0.11	4.0	0.5	8	16	0.03	0.05	30
	80	0	1.36	0.9	0.7	7.3	1.4	2.2	0.14	5.3	0.7	11	21	0.03	0.07	41
	100	0	1.61	1.2	0.9	8.9	1.8	2.6	0.16	6.7	0.8	14	27	0.04	0.08	51
	120	0	1.85	1.4	1.1	10.4	2.1	3.0	0.18	8.0	0.9	17	32	0.05	0.10	61
Maintenance plus growth																
	40	40	1.18	0.5	0.4	5.2	0.8	2.1	0.12	3.4	0.6	17	13	0.05	0.10	27
	60	60	1.67	0.8	0.6	7.5	1.2	3.0	0.17	5.1	0.8	26	20	0.08	0.15	40
	80	80	2.15	1.0	0.8	9.7	1.6	3.9	0.21	6.7	1.1	34	26	0.10	0.20	53
	100	100	2.61	1.3	1.0	12.0	2.0	4.7	0.26	8.4	1.3	43	33	0.13	0.25	67
	120	120	3.06	1.6	1.2	14.1	2.4	5.5	0.31	10.1	1.5	52	40	0.15	0.30	80
Breeding																
	40	60	1.27	0.5	0.4	5.5	0.9	2.3	0.13	3.7	0.6	23	14	0.07	0.13	30
	60	88	1.80	0.8	0.6	7.9	1.3	3.2	0.18	5.6	0.9	34	22	0.10	0.20	44
	80	115	2.31	1.1	0.9	10.3	1.7	4.2	0.23	7.4	1.2	44	29	0.13	0.26	59
	100	143	2.80	1.4	1.1	12.6	2.1	5.0	0.28	9.2	1.4	55	36	0.16	0.32	74
	120	170	3.29	1.6	1.3	14.9	2.5	5.9	0.33	11.0	1.6	66	43	0.19	0.38	88
Early gestation (Single lamb)																
	40	40	1.33	0.6	0.5	5.7	1.0	2.4	0.13	6.3	0.7	35	23	0.06	0.13	35
	60	60	1.85	0.9	0.7	8.1	1.4	3.3	0.19	8.6	0.9	47	31	0.09	0.19	51
	80	80	2.35	1.2	0.9	10.5	1.9	4.2	0.24	10.9	1.2	59	40	0.12	0.24	66
	100	100	2.85	1.4	1.1	12.8	2.3	5.1	0.28	13.2	1.4	71	48	0.15	0.30	81
	120	120	3.32	1.7	1.3	15.1	2.7	6.0	0.33	15.4	1.7	83	56	0.18	0.35	96

TABLE 15-3 continued

Class/Stage/Other	Body Weight ^a kg	Body Weight Gain ^c g/d	Dry Matter Intake ^d kg/d	Na g/d	Cl g/d	K g/d	Mg g/d	S g/d	Co mg/d	Cu ^e mg/d	I mg/d	Fe mg/d	Mn mg/d	Se ^f mg/d	Se ^g mg/d	Zn ^h mg/d
Early gestation (Twin lambs)																
	40	40	1.14	0.7	0.5	5.3	1.1	2.1	0.11	8.5	0.6	48	30	0.08	0.15	42
	60	60	2.00	1.0	0.7	8.7	1.6	3.6	0.20	11.4	1.0	64	40	0.11	0.21	59
	80	80	2.52	1.2	1.0	11.1	2.1	4.5	0.25	14.1	1.3	78	50	0.14	0.27	75
	100	100	3.04	1.5	1.2	13.5	2.5	5.5	0.30	16.8	1.5	93	60	0.17	0.33	92
	120	120	3.53	1.8	1.4	15.9	3.0	6.4	0.35	19.3	1.8	107	69	0.20	0.39	108
Early gestation (Three lambs)																
	40	40	1.20	0.7	0.5	5.5	1.2	2.2	0.12	9.9	0.6	56	34	0.08	0.17	46
	60	60	2.09	1.0	0.8	9.0	1.7	3.8	0.21	13.1	1.0	74	45	0.12	0.23	64
	80	80	2.64	1.3	1.0	11.5	2.2	4.7	0.26	16.2	1.3	91	57	0.15	0.30	82
	100	100	3.16	1.6	1.3	14.0	2.7	5.7	0.32	19.2	1.6	107	67	0.18	0.36	99
	120	120	3.67	1.9	1.5	16.4	3.2	6.6	0.37	21.9	1.8	122	77	0.21	0.42	115
Late gestation (Single lamb)																
	40	40	1.20	0.6	0.4	5.3	1.1	2.2	0.12	6.3	0.6	35	23	0.06	0.13	35
	60	60	2.07	0.8	0.7	8.8	1.5	3.7	0.21	8.6	1.0	47	31	0.09	0.19	51
	80	80	2.61	1.1	0.9	11.2	2.0	4.7	0.26	10.9	1.3	59	40	0.12	0.24	66
	100	100	3.14	1.4	1.1	13.6	2.4	5.7	0.31	13.2	1.6	71	48	0.15	0.30	81
	120	120	3.65	1.7	1.3	16.0	2.9	6.6	0.36	15.4	1.8	83	56	0.18	0.35	96
Late gestation (Twin lambs)																
	40	40	1.41	0.6	0.5	6.0	1.3	2.5	0.14	8.5	0.7	48	30	0.08	0.15	42
	60	60	1.90	0.9	0.7	8.3	1.8	3.4	0.19	11.4	1.0	64	40	0.11	0.21	59
	80	80	2.36	1.2	0.9	10.6	2.3	4.3	0.24	14.1	1.2	78	50	0.14	0.27	75
	100	100	2.81	1.5	1.1	12.8	2.8	5.1	0.28	16.8	1.4	93	60	0.17	0.33	92
	120	120	4.10	1.7	1.3	17.4	3.2	7.4	0.41	19.3	2.1	107	69	0.20	0.39	108
Late gestation (Three lambs)																
	40	40	1.54	0.6	0.5	6.4	1.4	2.8	0.15	9.9	0.8	56	34	0.08	0.17	46
	60	60	2.06	0.9	0.7	8.9	1.9	3.7	0.21	13.1	1.0	74	45	0.12	0.23	64
	80	80	2.57	1.2	0.9	11.3	2.5	4.6	0.26	16.2	1.3	91	57	0.15	0.30	82
	100	100	3.04	1.5	1.2	13.5	3.0	5.5	0.30	19.2	1.5	107	67	0.18	0.36	99
	120	120	3.49	1.8	1.4	15.7	3.5	6.3	0.35	21.9	1.7	122	77	0.21	0.42	115
Early lactation (Single lamb)																
	40	-14	1.40	0.8	1.3	6.8	1.4	2.2	0.28	6.4	1.1	8	15	0.17	0.34	44
	60	-17	1.82	1.1	1.7	9.1	1.9	2.9	0.36	8.8	1.5	11	21	0.21	0.43	59
	80	-20	2.19	1.4	2.0	11.2	2.4	3.5	0.44	11.1	1.8	14	27	0.25	0.50	74
	100	-22	2.54	1.7	2.4	13.3	2.8	4.1	0.51	13.3	2.0	18	33	0.28	0.57	88
	120	-24	2.86	1.9	2.7	15.2	3.3	4.6	0.57	15.5	2.3	21	39	0.32	0.63	102
Early lactation (Twin lambs)																
	40	-24	1.43	1.0	1.9	7.6	1.8	2.3	0.29	8.2	1.1	9	18	0.27	0.55	60
	60	-29	2.30	1.3	2.4	11.4	2.4	3.7	0.46	11.1	1.8	13	25	0.34	0.68	79
	80	-33	2.75	1.6	2.9	13.9	3.0	4.4	0.55	13.7	2.2	17	31	0.40	0.79	96
	100	-37	3.16	2.0	3.3	16.2	3.5	5.1	0.63	16.3	2.5	20	38	0.45	0.89	113
	120	-41	3.55	2.3	3.7	18.4	4.1	5.7	0.71	18.8	2.8	23	44	0.49	0.99	129
Early lactation (Three or more lambs)																
	40	-31	1.39	1.1	2.3	8.0	2.2	2.2	0.28	9.7	1.1	11	20	0.35	0.70	72
	60	-38	2.13	1.5	3.0	11.5	2.8	3.4	0.43	12.8	1.7	14	27	0.43	0.86	93
	80	-43	3.17	1.9	3.5	15.8	3.5	5.1	0.63	15.7	2.5	18	35	0.50	1.01	113
	100	-49	3.63	2.2	4.0	18.4	4.1	5.8	0.73	18.5	2.9	22	41	0.57	1.13	132
	120	-53	4.06	2.5	4.5	20.8	4.6	6.5	0.81	21.2	3.2	25	48	0.63	1.25	150
Late lactation (Single lamb)																
	40	55	1.53	0.6	0.7	6.6	1.1	2.5	0.31	5.9	1.2	24	16	0.12	0.23	37
	60	72	2.09	0.9	1.0	9.2	1.5	3.3	0.42	8.3	1.7	32	23	0.15	0.30	52
	80	95	2.64	1.2	1.3	11.7	2.0	4.2	0.53	10.8	2.1	42	30	0.19	0.38	68
	100	117	3.15	1.5	1.5	14.1	2.4	5.0	0.63	13.3	2.5	51	37	0.23	0.45	83
	120	138	3.64	1.8	1.8	16.5	2.9	5.8	0.73	15.8	2.9	61	44	0.26	0.52	98
Late lactation (Twin lambs)																
	40	65	1.46	0.7	0.9	6.6	1.2	2.3	0.29	6.8	1.2	28	18	0.16	0.32	44
	60	91	1.97	1.0	1.3	9.1	1.7	3.2	0.39	9.6	1.6	39	25	0.21	0.42	62
	80	117	3.07	1.3	1.6	13.3	2.2	4.9	0.61	12.3	2.5	50	33	0.26	0.52	79
	100	141	3.63	1.6	1.9	16.0	2.7	5.8	0.73	15.0	2.9	61	40	0.30	0.61	96
	120	166	4.19	1.9	2.2	18.6	3.2	6.7	0.84	17.6	3.4	71	47	0.35	0.70	113

TABLE 15-3 continued

Class/Stage/Other	Body Weight ^b kg	Body Weight Gain ^c g/d	Dry Matter Intake ^d kg/d	Na g/d	Cl g/d	K g/d	Mg g/d	S g/d	Co mg/d	Cu ^e mg/d	I mg/d	Fe mg/d	Mn mg/d	Se ^f mg/d	Se ^g mg/d	Zn ^h mg/d
Late lactation (Three or more lambs)																
	60	104	2.18	1.1	1.4	10.0	1.9	3.5	0.44	10.5	1.7	44	27	0.25	0.51	69
	80	132	2.71	1.4	1.8	12.6	2.4	4.3	0.54	13.4	2.2	56	35	0.31	0.62	88
	100	159	3.59	1.7	2.1	16.2	3.0	5.7	0.72	16.2	2.9	67	43	0.36	0.73	106
	120	185	4.58	2.0	2.4	20.1	3.5	7.3	0.92	19.0	3.7	78	50	0.41	0.83	123
Mature ewes																
Maintenance only																
	40	0	0.77	0.5	0.4	3.9	0.7	1.2	0.08	2.7	0.4	6	11	0.02	0.03	20
	60	0	1.05	0.7	0.6	5.6	1.1	1.7	0.10	4.0	0.5	8	16	0.03	0.05	30
	80	0	1.30	0.9	0.7	7.1	1.4	2.1	0.13	5.3	0.7	11	21	0.03	0.07	41
	100	0	1.54	1.2	0.9	8.7	1.8	2.5	0.15	6.7	0.8	14	27	0.04	0.08	51
	120	0	1.76	1.4	1.1	10.2	2.1	2.8	0.18	8.0	0.9	17	32	0.05	0.10	61
	140	0	1.98	1.7	1.3	11.6	2.5	3.2	0.20	9.3	1.0	20	37	0.06	0.12	71
Breeding																
	40	20	0.85	0.5	0.4	4.2	0.8	1.4	0.09	3.0	0.4	11	12	0.03	0.07	23
	60	26	1.15	0.7	0.6	5.9	1.1	1.8	0.12	4.5	0.6	16	18	0.05	0.09	35
	80	32	1.43	1.0	0.8	7.6	1.5	2.3	0.14	5.9	0.7	20	23	0.06	0.12	46
	100	38	1.69	1.2	1.0	9.2	1.9	2.7	0.17	7.3	0.8	25	29	0.07	0.15	57
	120	44	1.94	1.5	1.2	10.8	2.2	3.1	0.19	8.8	1.0	30	35	0.09	0.17	68
	140	50	2.18	1.7	1.3	12.3	2.6	3.5	0.22	10.2	1.1	34	40	0.10	0.20	79
Early gestation (Single lamb)																
	40	18	0.99	0.6	0.4	4.7	0.9	1.6	0.10	5.9	0.5	25	21	0.03	0.07	30
	60	24	1.31	0.8	0.6	6.5	1.3	2.1	0.13	8.0	0.7	32	29	0.05	0.09	42
	80	30	1.61	1.1	0.8	8.2	1.7	2.6	0.16	10.0	0.8	39	36	0.06	0.11	55
	100	35	1.89	1.3	1.0	9.9	2.1	3.0	0.19	11.9	0.9	46	44	0.07	0.14	66
	120	41	2.15	1.6	1.2	11.5	2.5	3.4	0.22	13.8	1.1	52	51	0.08	0.16	78
	140	46	2.39	1.8	1.4	13.1	2.9	3.8	0.24	15.6	1.2	57	57	0.09	0.18	90
Early gestation (Twin lambs)																
	40	30	1.15	0.6	0.5	5.2	1.1	1.8	0.11	8.3	0.6	40	29	0.04	0.09	37
	60	40	1.51	0.9	0.7	7.2	1.5	2.4	0.15	11.0	0.8	51	38	0.06	0.12	51
	80	50	1.84	1.2	0.9	9.0	1.9	2.9	0.18	13.5	0.9	60	48	0.07	0.15	65
	100	59	2.15	1.4	1.1	10.8	2.3	3.4	0.21	15.9	1.1	69	56	0.09	0.18	78
	120	68	2.44	1.7	1.3	12.5	2.8	3.9	0.24	18.1	1.2	78	64	0.10	0.20	91
	140	76	2.71	2.0	1.5	14.2	3.2	4.3	0.27	20.3	1.4	86	73	0.11	0.23	104
Early gestation (Three lambs)																
	40	39	1.00	0.7	0.5	4.9	1.2	1.6	0.10	9.9	0.5	49	34	0.05	0.11	42
	60	52	1.65	1.0	0.7	7.6	1.6	2.6	0.16	13.0	0.8	63	45	0.07	0.14	57
	80	65	2.00	1.2	1.0	9.6	2.1	3.2	0.20	15.8	1.0	74	55	0.09	0.17	72
	100	77	2.32	1.5	1.2	11.4	2.5	3.7	0.23	18.5	1.2	85	65	0.10	0.20	86
	120	88	2.63	1.8	1.4	13.2	2.9	4.2	0.26	21.0	1.3	95	74	0.12	0.23	100
	140	99	2.92	2.1	1.6	14.9	3.4	4.7	0.29	23.5	1.5	104	83	0.13	0.26	113
Late gestation (Single lamb)																
	40	71	1.00	0.5	0.4	4.7	1.0	1.6	0.10	5.9	0.5	25	21	0.03	0.07	30
	60	97	1.63	0.8	0.6	7.4	1.4	2.6	0.16	8.0	0.8	32	29	0.05	0.09	42
	80	120	1.98	1.0	0.8	9.2	1.8	3.2	0.20	10.0	1.0	39	36	0.06	0.11	55
	100	142	2.30	1.3	1.0	11.0	2.2	3.7	0.23	11.9	1.1	46	44	0.07	0.14	66
	120	163	2.61	1.5	1.2	12.8	2.6	4.2	0.26	13.8	1.3	52	51	0.08	0.16	78
	140	183	2.89	1.8	1.4	14.4	3.0	4.6	0.29	15.6	1.4	57	57	0.09	0.18	90
Late gestation (Twin lambs)																
	40	119	1.06	0.6	0.4	4.9	1.2	1.7	0.11	8.3	0.5	40	29	0.04	0.09	37
	60	161	1.65	0.8	0.6	7.5	1.7	2.6	0.17	11.0	0.8	51	38	0.06	0.12	51
	80	200	1.99	1.1	0.8	9.4	2.2	3.2	0.20	13.5	1.0	60	48	0.07	0.15	65
	100	236	2.87	1.3	1.0	12.8	2.6	4.6	0.29	15.9	1.4	69	56	0.09	0.18	78
	120	271	3.24	1.6	1.2	14.7	3.0	5.2	0.32	18.1	1.6	78	64	0.10	0.20	91
	140	304	3.57	1.9	1.4	16.6	3.5	5.7	0.36	20.3	1.8	86	73	0.11	0.23	104
Late gestation (Three or more lambs)																
	40	155	1.22	0.6	0.5	5.4	1.4	1.9	0.12	9.9	0.6	49	34	0.05	0.11	42
	60	210	1.57	0.9	0.7	7.3	1.9	2.5	0.16	13.0	0.8	63	45	0.07	0.14	57
	80	260	2.26	1.1	0.9	10.2	2.4	3.6	0.23	15.8	1.1	74	55	0.09	0.17	72
	100	307	2.59	1.4	1.1	12.1	2.8	4.1	0.26	18.5	1.3	85	65	0.10	0.20	86

TABLE 15-3 continued

Class/Stage/Other	Body Weight ^b kg	Body Weight Gain ^c g/d	Dry Matter Intake ^d kg/d	Na g/d	Cl g/d	K g/d	Mg g/d	S g/d	Co mg/d	Cu ^e mg/d	I mg/d	Fe mg/d	Mn mg/d	Se ^f mg/d	Se ^g mg/d	Zn ^h mg/d
	120	352	2.92	1.6	1.3	13.9	3.3	4.7	0.29	21.0	1.5	95	74	0.12	0.23	100
	140	396	4.04	1.9	1.5	18.0	3.8	6.5	0.40	23.5	2.0	104	83	0.13	0.26	113
Early lactation (Single lamb)																
	40	-14	1.09	0.8	1.3	5.9	1.4	1.7	0.22	6.4	0.9	8	15	0.17	0.34	44
	60	-17	1.77	1.1	1.7	9.0	1.9	2.8	0.35	8.8	1.4	11	21	0.21	0.43	59
	80	-20	2.13	1.4	2.0	11.1	2.4	3.4	0.43	11.1	1.7	14	27	0.25	0.50	74
	100	-22	2.47	1.7	2.4	13.1	2.8	4.0	0.49	13.3	2.0	18	33	0.28	0.57	88
	120	-24	2.78	1.9	2.7	15.0	3.3	4.4	0.56	15.5	2.2	21	39	0.32	0.63	102
	140	-26	3.08	2.2	3.0	16.8	3.7	4.9	0.62	17.7	2.5	24	45	0.34	0.69	115
Early lactation (Twin lambs)																
	40	-24	1.40	1.0	1.9	7.5	1.8	2.2	0.28	8.2	1.1	9	18	0.27	0.55	60
	60	-29	1.80	1.3	2.4	9.9	2.4	2.9	0.36	11.1	1.4	13	25	0.34	0.68	79
	80	-33	2.15	1.6	2.9	12.1	3.0	3.4	0.43	13.7	1.7	17	31	0.40	0.79	96
	100	-37	2.48	2.0	3.3	14.2	3.5	4.0	0.50	16.3	2.0	20	38	0.45	0.89	113
	120	-41	3.47	2.3	3.7	18.2	4.1	5.6	0.69	18.8	2.8	23	44	0.49	0.99	129
	140	-44	3.82	2.6	4.1	20.3	4.6	6.1	0.76	21.2	3.1	27	51	0.54	1.07	145
Early lactation (Three or more lambs)																
	40	-31	1.36	1.1	2.3	8.0	2.2	2.2	0.27	9.7	1.1	11	20	0.35	0.70	72
	60	-38	2.09	1.5	3.0	11.4	2.8	3.3	0.42	12.8	1.7	14	27	0.43	0.86	93
	80	-43	3.11	1.9	3.5	15.6	3.5	5.0	0.62	15.7	2.5	18	35	0.50	1.01	113
	100	-49	3.56	2.2	4.0	18.2	4.1	5.7	0.71	18.5	2.8	22	41	0.57	1.13	132
	120	-53	3.98	2.5	4.5	20.6	4.6	6.4	0.80	21.2	3.2	25	48	0.63	1.25	150
	140	-57	4.37	2.9	5.0	22.9	5.2	7.0	0.87	23.9	3.5	29	55	0.68	1.36	167
Early lactation (Parlor production only)																
	60	-52	2.14	1.8	3.9	12.7	3.5	3.4	0.43	15.7	1.7	17	32	0.59	1.18	117
	80	-60	3.04	2.2	4.6	16.7	4.3	4.9	0.61	19.0	2.4	21	40	0.68	1.37	141
	100	-67	3.46	2.6	5.2	19.3	5.0	5.5	0.69	22.2	2.8	25	47	0.77	1.54	163
	120	-73	3.86	3.0	5.8	21.8	5.6	6.2	0.77	25.3	3.1	29	54	0.85	1.69	184
	140	-79	5.29	3.3	6.4	27.2	6.2	8.5	1.06	28.2	4.2	32	61	0.92	1.84	204
Late lactation (Single lamb)																
	40	10	1.09	0.6	0.7	5.2	1.0	1.7	0.22	4.8	0.9	11	13	0.08	0.16	30
	60	12	1.43	0.9	0.9	7.1	1.4	2.3	0.29	6.9	1.1	15	19	0.10	0.20	43
	80	15	1.76	1.1	1.2	9.0	1.8	2.8	0.35	8.9	1.4	18	25	0.12	0.25	55
	100	17	2.05	1.4	1.4	10.8	2.2	3.3	0.41	10.9	1.6	22	30	0.14	0.29	67
	120	18	2.33	1.6	1.7	12.5	2.6	3.7	0.47	12.9	1.9	26	36	0.16	0.32	79
	140	20	2.60	1.9	1.9	14.2	3.0	4.2	0.52	14.9	2.1	29	42	0.18	0.36	91
Late lactation (Twin lambs)																
	40	25	1.38	0.7	0.9	6.3	1.1	2.2	0.28	5.8	1.1	16	15	0.13	0.25	38
	60	31	1.80	1.0	1.2	8.5	1.6	2.9	0.36	8.2	1.4	22	21	0.16	0.32	53
	80	37	2.19	1.2	1.5	10.6	2.1	3.5	0.44	10.4	1.8	27	28	0.19	0.38	67
	100	41	2.53	1.5	1.8	12.6	2.5	4.1	0.51	12.6	2.0	32	34	0.22	0.44	80
	120	46	2.87	1.8	2.0	14.5	2.9	4.6	0.57	14.8	2.3	36	40	0.25	0.50	93
	140	50	3.19	2.1	2.3	16.4	3.3	5.1	0.64	16.9	2.5	41	46	0.27	0.55	106
Late lactation (Three or more lambs)																
	60	44	2.06	1.0	1.4	9.5	1.8	3.3	0.41	9.1	1.7	27	23	0.20	0.41	60
	80	52	2.50	1.3	1.7	11.8	2.3	4.0	0.50	11.5	2.0	33	30	0.24	0.49	75
	100	59	2.89	1.6	2.0	14.0	2.7	4.6	0.58	13.9	2.3	38	36	0.28	0.56	90
	120	65	3.26	1.9	2.3	16.0	3.2	5.2	0.65	16.2	2.6	44	43	0.31	0.63	104
	140	70	3.59	2.2	2.6	18.0	3.6	5.8	0.72	18.4	2.9	49	49	0.34	0.69	118
Late lactation (Parlor production only)																
	60	50	2.35	1.1	1.7	10.7	2.0	3.8	0.47	10.3	1.9	30	25	0.26	0.53	69
	80	59	2.82	1.5	2.1	13.2	2.5	4.5	0.56	12.9	2.3	37	32	0.31	0.63	86
	100	66	3.25	1.8	2.4	15.5	3.0	5.2	0.65	15.4	2.6	43	39	0.36	0.72	102
	120	73	3.66	2.1	2.8	17.7	3.5	5.9	0.73	17.9	2.9	49	46	0.40	0.80	118
	140	80	4.05	2.3	3.1	19.9	4.0	6.5	0.81	20.3	3.2	55	52	0.44	0.88	133
Rams																
Maintenance only																
	100	0	1.77	1.2	0.9	9.3	1.8	2.8	0.18	6.7	0.9	14	27	0.04	0.08	51
	125	0	2.09	1.5	1.2	11.3	2.2	3.3	0.21	8.3	1.0	18	33	0.05	0.10	63
	150	0	2.40	1.8	1.4	13.3	2.6	3.8	0.24	10.0	1.2	21	40	0.06	0.13	76
	200	0	2.98	2.4	1.9	17.0	3.5	4.8	0.30	13.3	1.5	28	53	0.08	0.17	101

TABLE 15-3 continued

Class/Stage/Other	Body Weight ^a kg	Body Weight Gain ^c g/d	Dry Matter Intake ^d kg/d	Na g/d	Cl g/d	K g/d	Mg g/d	S g/d	Co mg/d	Cu ^e mg/d	I mg/d	Fe mg/d	Mn mg/d	Se ^f mg/d	Se ^g mg/d	Zn ^h mg/d
Prebreeding																
	100	47	1.95	1.2	1.0	9.9	1.9	3.1	0.39	7.5	1.0	28	30	0.08	0.16	58
	125	56	2.30	1.6	1.2	12.0	2.3	3.7	0.46	9.3	1.2	34	37	0.10	0.20	72
	150	64	2.64	1.9	1.5	14.1	2.8	4.2	0.53	11.1	1.3	40	44	0.12	0.23	86
	200	79	3.27	2.5	1.9	18.1	3.7	5.2	0.65	14.7	1.6	51	58	0.15	0.30	114

^aCalcium and phosphorus requirements for sheep are listed in Tables 15-1 and 15-2.

^bBody weight used in estimating requirements is the determined or estimated weight in kilograms (kg) average for the period during which these requirements will be applied.

^cAverage change in body weight over a 24-hour period.

^dEstimate of dry matter intake of a feed of appropriate energy density to meet energy requirements.

^eCopper absorption coefficients used were 0.06 for maintenance and gestation, and 0.045 for lactation.

^fSelenium absorption coefficient used was 0.60 applicable to concentrate diets.

^gSelenium absorption coefficient used was 0.30 applicable to forage diets.

^hZinc absorption coefficient used was 0.15.

Appendix III Example Rations for Sheep

The rations suggested here are based on the feed analyses given in Table II1 and apply to those analyses only. Profitable rations must be based on accurate analyses of the feeds on hand and, therefore, the formulae given here are intended for guidance only.

TABLE III1 ANALYSES OF FEEDS USED IN EXAMPLE RATIONS

FEED NAME	DM	TDN	CP	Ca	P	K	Mg	Fe	Mn	Zn	Cu	Mo	Se
				%	mg/kg								
Grass Hay	88.4	55.9	10.3	0.47	0.23	1.81	0.2	147	113	26	7	3.5	0.116
Gr/Legume Hay	87.3	54.2	11.8	0.87	0.22	2.06	0.24	133	59	24	8.7	3.1	0.126
Alfalfa Hay	88.7	57	16.4	1.33	0.27	2.47	0.28	251	35	23	9.7	2.6	0.189
Cereal Hay	86.4	60.9	9.5	0.37	0.26	1.95	0.18	194	55	26	7.8	2.4	0.033
Barley	88.6	81.4	11.2	0.11	0.38	0.53	0.15	119	22	45	11	1.7	0.06
Oats	87.7	76.9	10.9	0.1	0.34	0.7	0.13	79	48	37	7.8	2	0.035
Grass Silage	35.1	53.3	12.6	0.57	0.4	2.47	0.3	352	124	35	9.1	2.6	0.054
Gr/Leg Silage	34.4	53.3	15.5	0.93	0.26	2.28	0.25	287	76	31	8.7	3.2	0.155
Corn Silage	29.6	63.9	8.8	0.36	0.24	1.29	0.2	213	47	29	7	1.7	0.078
Cereal Silage	38.2	63.4	9.1	0.39	0.28	1.61	0.19	283	66	32	7.1	2.5	0.105
Veget Pasture	22	65	19.5	1.42	0.47	2.07	0.3	147	33.2	19.5	10	2.8	0.08
Boot Pasture	28	60	14	0.63	0.33	2.49	0.2	132	149	27	8.9	1.3	0.06
Mature Pasture	56	51	6.4	0.3	0.26	1.36	0.18	110	133	26	6.8	1.2	0.07
June Range	32	51	11	0.3	0.28	2.1	0.26	156	105	19	8.4	1.8	0.11
Aug Range	76	45	5.5	0.42	0.18	2.05	0.22	105	101	24	8.6	1.4	0.09
15% Ration	90	75	15	0.7	0.5		0.25				8		0.1
20% Blocks	90	80	20	2.5	1		0.2		400	830	18		
32% Supp	90	80	32	4	1		0.3		400	1000	18		0.1
Lamb Supp	90	80	32	4	1	4	0.3	100	200	100	12		0.2
TM-Se Salt	90								1200	4000	330		25
1/1 Mineral	90			19	17		2	9000	6000	9000	15		30
2/1 Mineral	90			19	9		3	9000	6000	9000	15		30

TABLE III2 MAINTENANCE RATIIONS FOR 70kg EWES

FEED NAME	Ration Alternatives							
	1	2	3	4	5	6	7	8
Grass Hay	1.35							
Cereal Hay							1.38	
Barley					0.24			
Oats		0.23				0.95		
Cereal Silage								3.01
Boot Pasture			4.26					
Mature Pasture						0.61		
June Range		3.11						
Aug Range				1.11	1.12			
20% Blocks				0.39				0.05
32% Supp					0.15			
TM-Se Salt	12g	7g	7g	7g	6g	10g	9g	10g
2/1 Mineral							17g	

TABLE III3 MAINTENANCE RATIONS FOR 70kg EWES

FEED NAME	Ration Alternatives							
	1	2	3	4	5	6	7	8
Gr/Legume Hay		1.32						
Alfalfa Hay	0.35		1.35					
Barley		0.05			0.10			
Oats	0.15					0.11		
Grass Silage					3.15			
Gr/Leg Silage						3.19		
Corn Silage							3.57	
Cereal Silage								2.91
Boot Pasture				4.26				
Mature Pasture	1.35							
15% Ration							0.15	0.09
TM-Se Salt	10g	5g	6g	7g	8g	6g	12g	12g

TABLE III4 FLUSHING RATIONS FOR 70kg EWES

FEED NAME	Ration Alternatives							
	1	2	3	4	5	6	7	8
Grass Hay	1.74							
Gr/Legume Hay		1.59						
Alfalfa Hay			1.8					
Cereal Hay				2.07				
Barley	0.28					0.42		0.66
Oats		0.46	0.22					
Corn Silage							5.65	
Boot Pasture					6.39			
Mature Pasture						2.31		
Aug Range								1.43
15% Ration							0.12	
32% Supp						0.14		0.13
TM-Se Salt	15g	9g	6g	14g	11g	10g	18g	

TABLE III5 EARLY GESTATION RATIONS FOR 70kg EWES

FEED NAME	Ration Alternatives					
	1	2	3	4	5	6
Grass Hay	1.57					
Gr/Legume Hay		1.52				
Alfalfa Hay			1.57			
Cereal Hay				1.58		
Barley					0.06	0.11
Oats		0.07				
Grass Silage						3.68
Mature Pasture					2.12	
15% Ration				0.03		
32% Supp					0.17	
TM-Se Salt	14g	6g	7g	11g	9g	9g

**TABLE III6 LATE GESTATION RATIONS FOR 70kg EWES
(130-150% LAMBING RATE EXPECTED)^a**

FEED NAME	Ration Alternatives			
	1	2	3	4
Grass Hay	1.68			
Gr/Legume Hay		1.68		
Alfalfa Hay			1.8	
Cereal Hay				1.59
Barley		0.37		
Oats	0.31		0.22	
15% Ration				0.46
32% Supp	0.04			
TM-Se Salt	17g	7g	6g	13g

^a these rations are also suitable for 70kg ewes in last 4-6 weeks of lactation suckling singles

**TABLE III7 LATE GESTATION RATIONS FOR 70kg EWES
(180-225% LAMBING RATE EXPECTED)**

FEED NAME	Ration Alternatives			
	1	2	3	4
Grass Hay	1.35			
Gr/Legume Hay		1.10		
Alfalfa Hay			1.38	
Cereal Hay				1.60
Barley	0.72		0.74	
Oats		1.06		0.39
32% Supp	0.07			0.18
TM-Se Salt	9g	11g	17g	14g

**TABLE III8 EARLY LACTATION RATIONS FOR 70kg EWES
SUCKLING SINGLES^a**

FEED NAME	Ration Alternatives			
	1	2	3	4
Gr/Legume Hay	1.68			
Alfalfa Hay		1.82		
Barley	0.9	0.98		
Oats				0.09
Cereal Silage			5.28	
Veget Pasture				10.96
32% Supp	0.25		0.53	
TM-Se Salt	11g	23g	11g	15g

^a these rations are also suitable for 70 kg ewes in last 4-6 weeks of lactation suckling twins

**TABLE III9 EARLY LACTATION RATIIONS FOR 70kg EWES
SUCKLING TWINS**

FEED NAME	Ration Alternatives			
	1	2	3	4
Gr/Legume Hay	1.71			
Alfalfa Hay		2.10		
Barley		1.00		0.08
Oats	0.92		1.30	
Gr/Leg Silage			4.09	
Veget Pasture				12.35
32% Supp	0.54	0.06	0.27	
TM-Se Salt	13g	7g	12g	19g

TABLE III10 EARLY GESTATION RATIIONS FOR 60kg EWE LAMBS

FEED NAME	Ration Alternatives			
	1	2	3	4
Grass Hay	1.45			
Gr/Legume Hay		1.42		
Alfalfa Hay			1.62	
Cereal Hay				1.52
Barley			0.17	0.23
Oats		0.41		
15% Ration	0.33			
32% Supp				0.07
TM-Se Salt	16g	8g	9g	11g

**TABLE III11 LATE GESTATION RATIONS FOR 60kg EWE LAMBS
(100-120% LAMBING RATE EXPECTED)**

FEED NAME	Ration Alternatives			
	1	2	3	4
Grass Hay	1.21			
Gr/Legume Hay		1.08		
Alfalfa Hay			1.32	
Cereal Hay				1.22
Barley	0.44			0.56
Oats			0.60	
15% Ration		0.83		
32% Supp	0.12			0.16
TM-Se Salt	8g	12g	5g	12g

**TABLE III12 LATE GESTATION RATIONS FOR 60kg EWE LAMBS
(130-175% LAMBING RATE EXPECTED)**

FEED NAME	Ration Alternatives			
	1	2	3	4
Grass Hay	1.00			
Gr/Legume Hay		1.07		
Alfalfa Hay			1.02	
Cereal Hay				0.88
Barley		0.73		0.83
Oats	0.72		0.90	
15% Ration				
32% Supp	0.20	0.12		0.22
TM-Se Salt	9g	8g	7g	11g

**TABLE III13 EARLY LACTATION RATIIONS FOR 60kg EWE LAMBS
SUCKLING SINGLES**

FEED NAME	Ration Alternatives			
	1	2	3	4
Gr/Legume Hay			1.45	
Alfalfa Hay				1.38
Barley			0.96	
Oats	0.29			1.21
Veget Pasture	9.24			
Boot Pasture		4.73		
15% Ration		1.07		
32% Supp			0.20	
TM-Se Salt	13g	13g	10g	9g

**TABLE III14 EARLY LACTATION RATIIONS FOR 60kg EWE LAMBS
SUCKLING TWINS**

FEED NAME	Ration Alternatives			
	1	2	3	4
Gr/Legume Hay		1.00		
Alfalfa Hay			1.09	
Barley	0.78			
Oats		1.50	1.64	1.25
Corn Silage				3.23
Veget Pasture	8.11			
32% Supp		0.34	0.10	0.48
TM-Se Salt	23g	14g	12g	15g

TABLE III15 GROWING RATIONS FOR REPLACEMENT EWE LAMBS

FEED NAME	Ration Alternatives							
	1 30kg	2 30kg	3 40kg	4 40kg	5 50kg	6 50kg	7 60kg	8 60kg
Grass Hay						1.45		1.45
Gr/Legume Hay		0.60		0.70				
Barley	0.34		0.39			0.23		0.23
Boot Pasture	3.2		3.73		5.33		5.33	
15% Ration		0.73		0.86				
TM-Se Salt	5g	16g	9g	19g	9g	13g	9g	13g
2/1 Mineral	2g							

TABLE III16 GROWING RATIONS FOR REPLACEMENT RAM LAMBS

FEED NAME	Ration Alternatives					
	1 60kg	2 60kg	3 80kg	4 80kg	5 100kg	6 100kg
Grass Hay		1.69		2.23	2.39	
Gr/Legume Hay	1.70		1.91			2.04
Barley				0.92	0.99	
Oats	1.14		1.28			1.37
15% Ration		1.10				
TM-Se Salt	14g	22g	16g	18g	19g	17g

TABLE III17 MARKET LAMB RATIIONS

FEED NAME	Ration Alternatives						
	MODERATE GROWTH		RAPID GROWTH		FINISHING		
	1 20kg	2 30kg	3 20kg	4 30kg	5 30kg	6 40kg	7 50kg
Gr/Legume Hay						0.32	
Barley	0.81	1.18	0.98	1.28	1.21	1.44	1.36
Corn Silage							1.10
Lamb Supp	0.31	0.27	0.37	0.3	0.25	0.03	0.06
1/1 Mineral	4g	5g	5g	6g	6g	13g	17g

INDEX

Abomasum.....	10,11	Cellulase	12
- and protein digestion.....	15	Cellulose	12
- capacity.....	8	- digestion.....	13
Acetic acid.....	12	- in ADF.....	4
Acid detergent fibre.....	4	Chlorine	23
Acid detergent		Chlorophyll	2,28
Insoluble nitrogen.....	5	Chlortetracycline.....	64
Acidosis	51,61	Cl (see chlorine)	
Additives – in feed.....	63	Co (se cobalt)	
ADF (see acid detergent fibre)		Cobalt	23,24,27,51
ADIN (see acid detergent insoluble nitrogen)		Cold stress.....	20-21
Alkalosis	16	Colostrum	
Amino acids.....	13	- for newborn lambs.....	53
- balance.....	14,17	- from goats and cows.....	54
- essential.....	15	- production by ewe.....	34
Amino group.....	13,15,23	Condition score	
Ammonia	15,22	- ewes.....	30,48-49
- from urea degradation.....	16	- lambs.....	41,65
Amprolium.....	64	Copper.....	23, 27,28,46
Aureomycin.....	64	- deficiency.....	24,28,46
Anaerobic	12	- molybdenum and sulfur.....	24
		CP (see crude protein)	
Balanced rations.....	29	Creep	
Behavior		- area.....	54
- feeding.....	61	- feeder.....	55
- in creep feeding.....	56	- feeding on pasture.....	57-58
Bovatec	64	- grazing.....	57
Breeding		- panels.....	55
- ewes.....	32	- ration.....	56
- ewe lambs.....	36,41	Crude protein (see protein)	
- rams.....	42	Cu (see copper)	
- ram lambs.....	42	Cud.....	9
Breeds			
- effect on condition score.....	49	DE (see digestible energy)	
- effect on flushing.....	32	Digestible energy.....	4,19
- effect on lamb growth.....	39	- relationship to TDN.....	4
British Columbia feeds.....	7	Digestion	8-17
Bushel weight.....	6	- carbohydrate.....	12,13
Butyric acid.....	12	- monogastric.....	8, 12,14
Bypass protein.....	17	- protein.....	13-17
		- sheep.....	8-17
Ca (see calcium)		Digestive system	
Calcium.....	23,25,27	- monogastric.....	8
- /phosphorus ratio.....	24	- ruminant (sheep).....	9-11
Carbohydrate.....	2	Dry matter.....	3
- digestion.....	12,13		
• In monogastric.....	12	Embryo mortality	
• In sheep.....	12,13	- in ewes.....	33
- digestion rate.....	12,13,16,17	Energy (see also TDN)	
- readily fermentable.....	13,16	- and environment.....	20
- reserves, in plant.....	2	- and physical activity.....	21
Carbon dioxide.....	2,12	- apparent digestible.....	19
Carotene.....	3	- deficiency.....	19
- as source of vitamin A.....	28	- digestible.....	4,19
Castration	63	- metabolizable.....	4,19-20
Cecum.....	8,10	- net.....	20
- capacity.....	8	- partition.....	19
- monogastric.....	8	- /protein balance.....	23
- sheep.....	10	- sources.....	23
		- utilization efficiency.....	20,32,35

Enzymes.....	8,9	• quality.....	14-15
- cellulase	13	- quality.....	7
- microbial	13	- rations based on.....	2
- urease.....	9,15,16	Forward creep grazing.....	57
Esophageal groove	11	Fructose.....	2
Esophagus	9,11		
Ewes		Gain	
- nutrient requirements	30-36	- average daily	35,39,59
- feed intake	31	- cost efficient	59
Ewe lambs		- effect of breed.....	39
- special requirements	36-37	- effect of sex.....	40
- targets.....	36	- efficiency.....	20
- growing replacements.....	41-42	- in flushing ewes	32
		- in lambs	39
F (see fluorine)		- in pregnant ewes.....	29-30
Fat		Galactose.....	2,12
- as energy store	20	Glucose.....	2,12
- in plants	2	Grain	
- vs. lean growth	40	- as energy source	21
Fe (see iron)		- bushel weight	6
Feed		- in creep rations.....	56
- additives	63-64	- in feeder rations.....	39,54
- allocation	49-50	- in lamb rations.....	39,54,60-61
- analysis.....	3-6	- overload.....	9,13,16
- bunk design	50	- protein	
- changes.....	9,51	• degradability	17
- conversion efficiency	54,58-59	• quality.....	14
- efficiency (lambs)	41	- quality.....	7
- intake		- sampling.....	44
• <i>ad lib</i>	31,38-39,50,60	- starch in.....	2,6
• and environment	20-21	- whole	
• and fibre.....	22,31	• digestion of	10,61
• and ration energy levels.....	20	• in creep rations.....	56
• and water.....	18,38	• in feeder rations	39,54
• ewes	31,37,40,59	• in lamb rations.....	39,54,61
• lambs	31		
• restricted.....	31,50	Grazing	
- quality.....	7	- ewes	31
• and maturity.....	7, 62	- forward creep.....	57,58
• and weathering.....	7	- lambs	57-58
• grasses vs. legumes.....	3,7	- management	53,57,58,62
• harvesting losses.....	7	- paddock.....	57
• leaves vs. stems.....	7	- rotational.....	57
- restriction	31,50	- strip.....	57
- sampling	43-44	Growth (see gain)	
- wasting	50		
Feeding behavior	61-62	Hay	
Fermentation		- heat damage in.....	4,17
- in rumen/reticulum.....	9,11,13,17	- protein	
Fetus		• degradability.....	17
- growth	33-34	• quality.....	14
- efficiency of growth.....	20	- quality	7
Fibre	2,4,13,22,31	- sampling	43
Fluorine	23,28	Heat damage	
Flushing		- and ADIN	5,17
- ewes	32	- and bypass protein	17
- rams	42	- in hay.....	4,17
Forages		- in silage.....	4,17
- as protein source	23	Heat of production	20,21
- growth of.....	2	Heat stress	20,21
- processing of.....	61	Hemicellulose	2
- protein		- digestion	13
• degradability	17		
		I (see iodine)	

Insulation	
- effect on energy requirements	21,48
Intake	
- <i>ad lib</i>	31,38,50,60
- ewes	31-32
- lambs	38,60
- pasture	31,37,57-58
- restricted	31, 50,58
Iodine	23,24,27,28
Iron	23,27
K (see potassium)	
Keto acids	12,15,16
Lactation	34-35
- and lamb gain	35
- effect of energy	35
- effect of multiple lambs	35
- effect of protein	35
- efficiency	20
Lactic acid	13,51
Lactose	12
Lamb(s)	
- feed intake	38-39,60,61
- feedlot	60
- finishing	41,64,65
- growth	
• pattern	38
• postweaning	40-41
• preweaning	40
- market	
• appraisal	64-65
• price	41,60
- marketing	41,60,63,64
- newborn	10,11,53-54
- orphan	11,52-54
- pasture	57-58,62-63
- price cycle	41
- psychology	56
Large intestine	
- capacity	8
- carbohydrate digestion in	8,10
- microbes in	8
- monogastric	8
- ruminant (sheep)	10
Legumes	3,7
Lignin	2
- in ADF	4
- in mature forage	13
Limestone	27
Lower critical temperature	20,21
Magnesium	23,25
- in chlorophyll	3
Maintenance	
- and gain	29-39
- energy for	20
- lambs	39
- period, ewes	31-32
Mammary gland development	34
Manganese	23,26
Market lamb appraisal	64-65
Metabolizable Energy	4,19-20
- relationship to TDN	4
Mg (see magnesium)	
Microbes	
- and ration changes	9
- establishment in rumen	10-11
- inoculation of	11
- in large intestine	8
- in rumen and reticulum	9,10,11
Microbial protein	14,15,16,17
Milk replacer	54,59
Mineral(s)	
- feeder	52
- feeding	51-52
- in feed analysis	5-6
- plants	3
- interactions	23-24,27
- macro	6,23
- requirements	23-27
- sources	24,27,28
- trace	6,23
Mn (see manganese)	
Mo (see molybdenum)	
Molybdenum	23,24,26
- copper and sulfur	24
Monensin	64
Most limiting nutrient	29
Mould	
- in hay	4
Na (see sodium)	
Net energy	19-20
Nipple	
- cross-cut	11,54
- pail	54
- rounded-holed	11
Nitrates	2,4
Nitrogen	
- fixation	3
- in protein	4-5
- metabolic fecal	10,22
- non-protein (see urea)	
NPN (see non-protein nitrogen)	
Oil	2
Omasum	10
- capacity	8
Orphan lambs	54
Ovulation	
- rate, and flushing	32-33
P (see phosphorus)	
Palatability	
- and feed intake	38
- and forage quality	31
- improvement with flavors	62
- of creep ration	55
- of mineral mixes	46,52
Pasture	
- annual	63
- creep feeding on	57
- lambs	62-63
- management	53,57,58,61
Pearson square	44-47
Pentosans	2
- digestion of	13

Pentose.....	2	- pH.....	13,16
pH		Root reserves.....	2
- in rumen/reticulum.....	13,16	Rumen.....	9
Phosphorus.....	23,24,25,27,28	- capacity.....	8
- in proteins.....	2,13	- development.....	10-11
Photosynthesis.....	2	- gases.....	9,19
Placenta.....	33,34	- microbes.....	9-10
Pot-bellied lamb.....	11	- papillae.....	9
Potassium.....	23,24	- pH.....	13,16
		- stasis.....	9
Pregnancy		S (see sulfur)	
- early.....	33	Saliva.....	9,15,16
- mid.....	33-34	- enzymes in.....	9
- late.....	34	- urea in.....	15,16
- requirements.....	33-34	Salivary glands.....	8
Pregnancy toxemia.....	19,34	Salt.....	24,50-51
Priority for nutrients.....	29	- trace mineralized.....	27,52
Processing		Se (see selenium)	
- forages.....	50,61	Selenium.....	23,24,27,28,29 46,47,51,52,53
- grain.....	11,61-62	- deficiency.....	46-47
Propionic acid.....	12	Self-feeders.....	50
Protein		Shearing	
- apparent digestible.....	22	- lambs.....	63
- bypass.....	17	- ewes.....	30
- crude.....	4	Silage	
- deficiency.....	22	- and Listeriosis.....	6
- degradability.....	17	- heat damage.....	7,17
- degradation.....	15	- nutrient leaching.....	3
- digestible.....	22	- pH.....	6
- digestion.....	13-17	- sampling.....	44
- /energy balance.....	17	- spoilage.....	6,17
- heat damaged.....	4,17	Slotted floors.....	62
• and ADIN.....	5	Small intestine	
- in feed analysis.....	4	- capacity.....	8
- in wool.....	3	- enzymes.....	8
- metabolic fecal.....	16,22	- monogastric.....	8
- metabolizable.....	22-23	- ruminant (sheep).....	10-11
- microbial.....	14,16,17	Sodium.....	23,24,27
- partition.....	22	Soya meal	
- plant.....	2-3	- in creep ration.....	61
- quality.....	14-15	- protein	
- requirements.....	22-23	• degradability.....	17
- sources.....	23	• quality.....	14
- supplements.....	23	Spinous process.....	47,63
- /TDN ratio.....	16	Stocking rate	
- true digestible.....	22	- effect on production.....	53
Rams		Starch	
- nutrient requirements.....	42	- in plants.....	2
- flushing.....	42	- digestion.....	8,12,13
Ration		Stomach	
- formulation.....	43-47	- acids.....	8
• Pearson square.....	43-46	- capacity.....	8
• Computerized.....	47	- enzymes.....	8
- recipes.....	47	- monogastric.....	8
- sorting.....	62	- ruminant (sheep).....	10-11
Recipes (see ration recipes)		Sugars.....	2
Reticulo-omasal orifice.....	10	- digestion.....	12
Reticulum.....	8	Sulfur.....	2,23,24,25
- development.....	10-11	- copper and molybdenum.....	24
- microbes.....	9-10	- in proteins.....	2
- papillae.....	9	Targets	
		- ewes.....	30
		- ewe lambs.....	36-37

TDN (see total digestible nutrients)		- requirements.....	27-28
Terramycin	64	- sources.....	29
Thermoneutral zone	20	Volatile Fatty Acids	12
Total digestible nutrients (see also energy)	4	- and rumen development.....	11
- /protein ratio	16		
- relation to ADF.....	4	Water	
Transverse process	48,65	- as nutrient.....	18
		- consumption	18-19
Udder (see mammary gland)		- in feed.....	3,18
UDP (see bypass protein)		- intake	18
Undegradable dietary protein (see bypass protein)		Weaning	58
Upper critical temperature	20,21	- and rumen development.....	11
Urea		- early	59
- for lambs	40,41	- in confinement.....	59
- in feed	16-17	- on pasture	59
- in saliva	16,17	Whole grain (see grain, whole)	
- recycling	17	Wool	
Urease	9,16,17	- protein.....	3
Vertebrae.....	48	Zinc.....	23,26
VRA (see volatile fatty acids)		- deficiency	46
Vitamins		Zn (see zinc)	
- administering	52-53		
- in plants	3		

THE NATIONAL ACADEMIES PRESS LICENSE
TERMS AND CONDITIONS

Jul 07, 2008

This is a License Agreement between BC Ministry of Agriculture & Lands ("You") and The National Academies Press ("The National Academies Press"). The license consists of your order details, the terms and conditions provided by The National Academies Press, and the payment terms and conditions.

License Number	1983720671261
License date	Jul 07, 2008
Licensed content publisher	The National Academies Press
Licensed content title	Nutrient Requirements of Small Ruminants: Sheep, Goats, Cervids, and New World Camelids
Licensed content author	Committee on the Nutrient Requirements of Small Ruminants, National Research Council
Licensed content date	2007
Type of Use	Print Republishing
Portion of the book	Figures/tables/images
Number of figures/tables	1
Location of portion(s)	The Nutrient Requirements of Sheep Tables 2006 will be placed as Appendix II in "NUTRITION GUIDE for B.C. Sheep Producers" starting from Page 64. It will replace the existing Appendix II "Nutrient Requirements of Sheep": Sixth Revised Edition 1985.
Title of the work	NUTRITION GUIDE for B.C Sheep Producers
Publication format	Book
Publisher of the work	BC Ministry of Agriculture, Fisheries and Food
Expected publication date	August 29, 2008
Order reference number	
Company	BC Ministry of Agriculture & Lands
Billing Address	BC Ministry of Agriculture and Lands 1767 Angus Campbell Road Abbotsford, BC V3G 2M3 Canada
Billing Type	Invoice
Total	50.00 USD
Terms and Conditions	

**The National Academies Press
Rightslink User Terms and Conditions**